

GATES

CATALOG

**Radio
Broadcasting
Equipment**

The Gates—

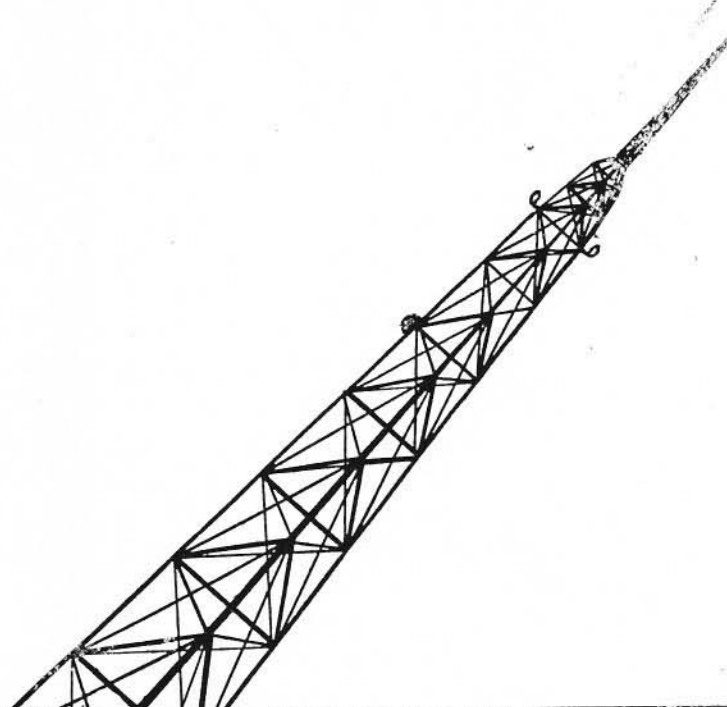

100-A

250-A

Transmitters

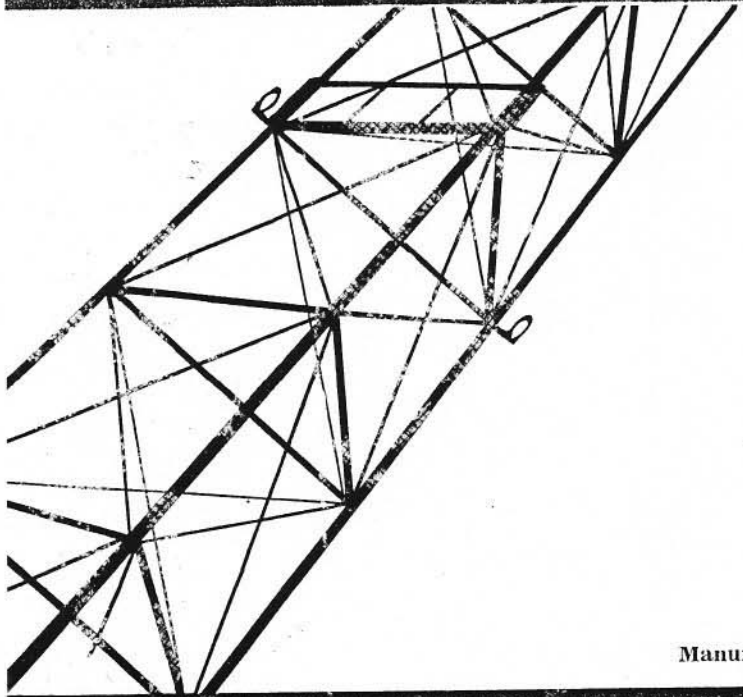

Manufactured by

The GATES AMERICAN CORPORATION
of
Quincy, Illinois, U. S. A.

Cable Address: GATEUSA

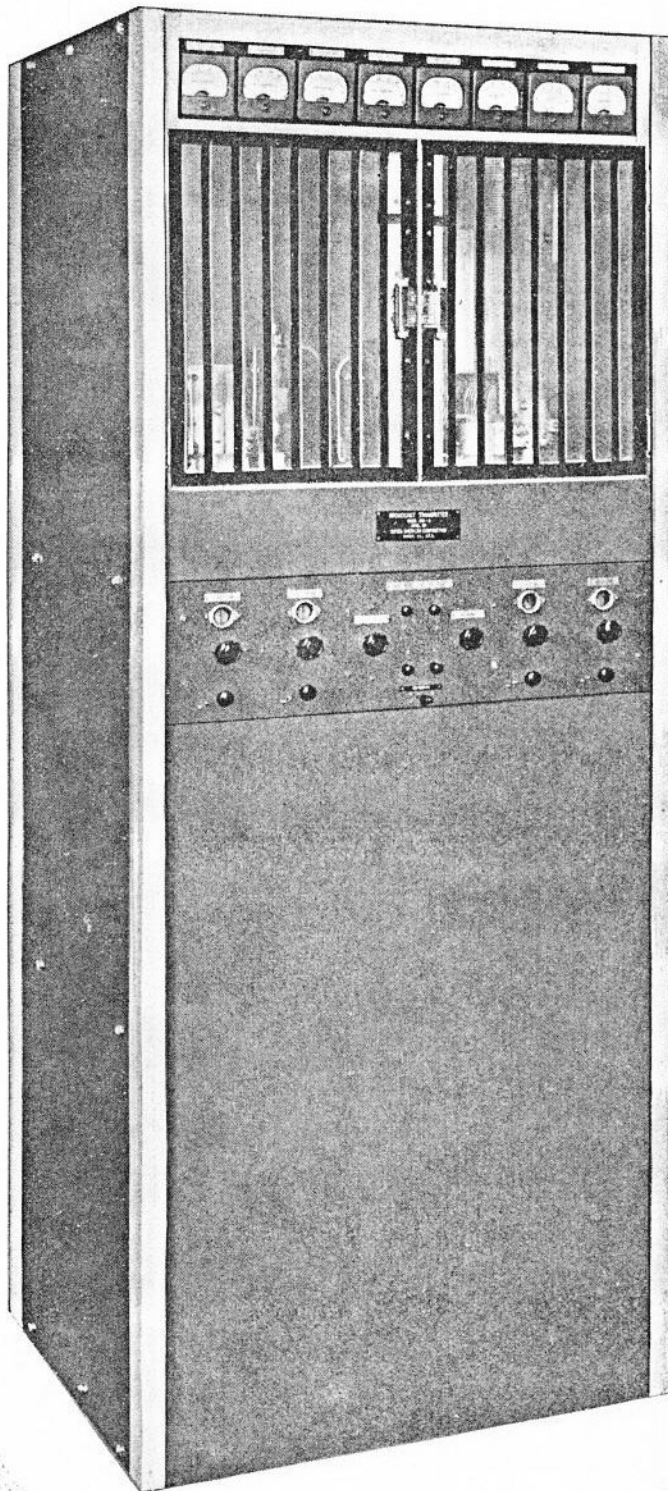

The 100-A for 100 Watts
The 250-A for 100-250 Watts
(Construction and Appearance Identical)

The 250-A TRANSMITTER

This latest in transmitters has feature added to feature, places all performance records on the shelf and hangs up a new one that gives a new meaning to high fidelity, low operating cost and beauty of appearance.

- The 250-A is the only broadcast transmitter having as standard equipment a peak limiting speech amplifier equipment.
- Low Power Consumption: 1700 watts at 250 watts carrier.
1300 watts at 100 watts carrier.
- Complete metering without switches. Eleven full size meters.
- Primary circuit breaker and secondary overload relay protection. No fuses.
- Dual temperature controlled crystal ovens with maximum of 3 cycle variation.
- High efficiency circuit—low cost tube complement for economical replacement—only one neutralized R. F. stage.
- Complete ceramic insulation in R. F. stages.
- Higher fidelity transmission. A new era in added low and high frequency response.
- Power change on 100-250 watt model all by one key automatically controlling carrier power, audio power and modulation monitor excitation through relays.
- Complete automatic starting, relay protection in bias circuits, time delay, door interlock all by relays.
- First quality parts throughout. Linear standard audio components, no electrolytic condensers, low temperature rise power supply.
- Extremely low hum level (—60 Db). Low harmonic content. Unusually fine power regulation (4% or better).
- High efficiency (72% or greater). Untuned oscillator for stability. Three buffer stages. 100% modulation can be obtained at 250 watts carrier with only 66% modulator capacity.

250-A DESCRIPTION

The 250-A Transmitter is divided into three sections, all which go to make the one complete transmitting equipment. Both the 100-A and the 250-A Transmitters are the same in construction and appearance. For sake of convenience both models will hereafter be referred to as the 250-A. The 100-A Transmitter differs from the 250-A in tube complement only and the 100-A, which is for 100 watts operation, may be converted to 250 watts by simply changing the tube complement in the final radio frequency and modulator stages. The power supply and all other component parts are the same size in either model.

Description will be made under three headings covering the main transmitter equipment, the frequency control equipment and the audio compressor or peak limiting amplifier equipment. A fourth heading giving technical detail covers the entire transmitter.

Frequency Control Unit

The frequency control panel for the 250-A Transmitter contains the oscillator, first and second buffer stages, power supply and dual crystal ovens. This panel is 10½ inches by 19 inches in size with vertical rear chassis construction. This allows use of the frequency control unit either in a rack cabinet or as a desk mount instrument, the latter being very popular as it places the one control, namely, the oscillator frequency adjustment, that must be checked at specified intervals for the log, at the operator's finger tips without leaving his control desk position. The output of the frequency control panel is link coupled to the main transmitter cabinet.

The crystal oven employed is of the Bliley BC46T design guaranteed accurate within 3 cycles when used with AT cut crystals which are supplied as standard with the 250-A equipment. The use of dual ovens provides complete protection in absolute frequency control with not just a spare crystal but a spare oven if needed.

The oscillator stage is of the untuned type which along with the balance of the circuit design makes it almost an impossibility to go out of oscillation or become unstable regardless of conditions in the succeeding radio frequency stages. A type RK25 tube is employed which is directly interchangeable with a type 802 tube.

The first buffer stage employs a type 45 tube completely untuned in both grid and plate circuits. This stage acts primarily as an isolation stage between the oscillator and the balance of the transmitter adding tremendously to the frequency stability.

The second buffer stage employs a type RK25 tube which is directly interchangeable with a type 802 tube if desired. This stage has a tuned plate circuit and this feeds to a link which couples to the main transmitter. The power supply delivers all filament and plate voltage, provides a completely filtered direct current to the above mentioned stages and employs the highest quality parts throughout such as absence of electrolytic filter condensers and low temperature rise transformers. Heater transformer for the crystal ovens is separate and can be turned off only by a rear switch. Connections are made to a numbered terminal strip located at the rear of the chassis.

Metering provided covers the oscillator plate current, second buffer grid and second buffer plate. All meters are full 3-inch type and no midget type meters are employed.

The 25-A frequency control unit is featured by complete absence of neutralizing, complete shielding, ability of quick access to all parts when required and unusual frequency stability. Tuning range may be had for any frequency from 1600 to 550 Kc. with other frequencies either higher or lower available on special order. Radio frequency output is 12 watts.

Finish is in steel gray ripple enamel with trimmings in burnished silver.

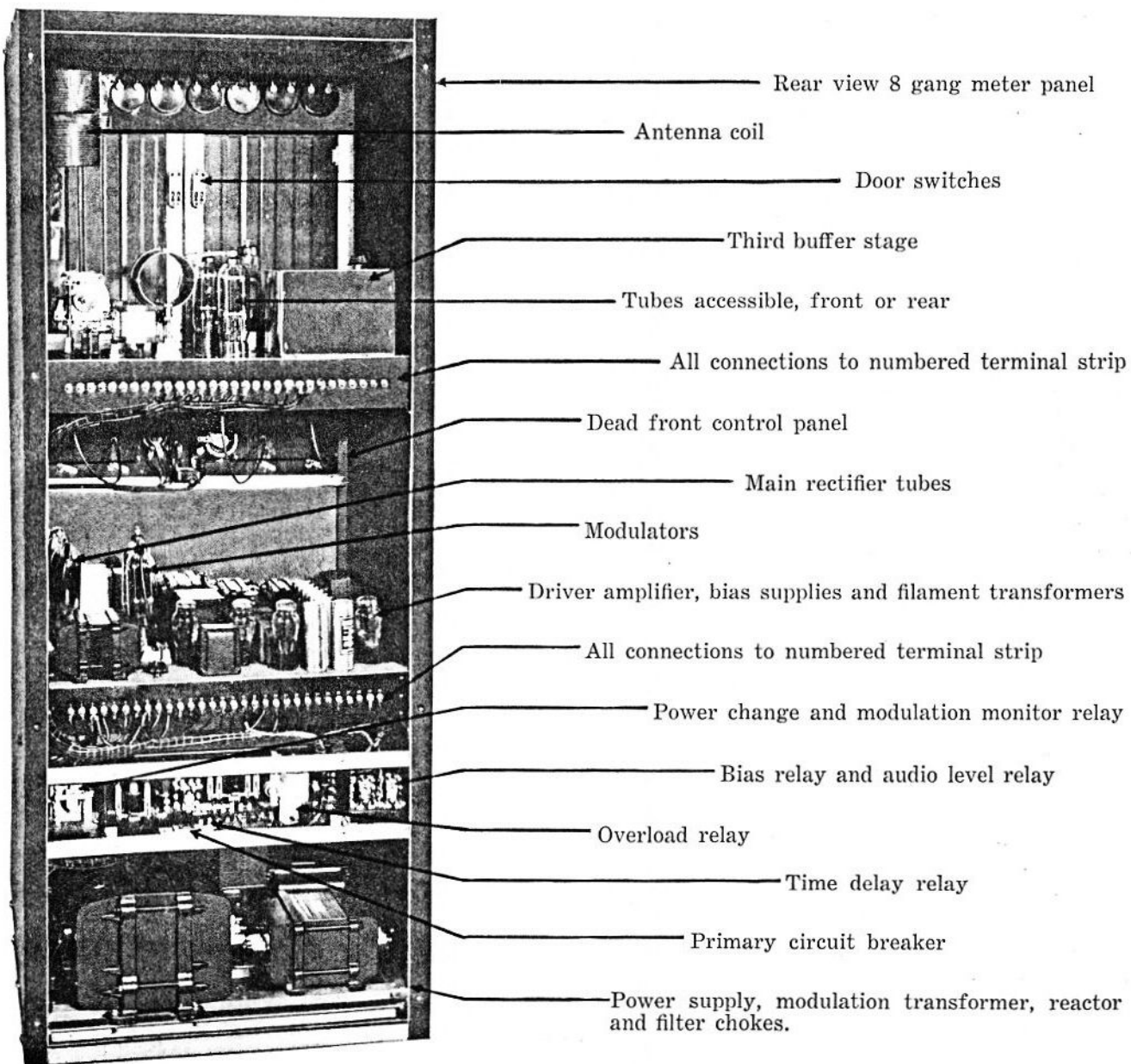

Rear View

It has often been said that neat well balanced design of any instrument indicates care in assembly and manufacture as well as much thought in original planning. In this rear view of the Gates 250-A Transmitter is illustrated how completely attractive the inner construction can be made both from an appearance and convenience standpoint. Note that every part can be quickly reached for servicing if required. There is ample space for full ventilation, and maintenance, yet no wasted space.

MAIN 250-A TRANSMITTER

The main transmitter cabinet contains virtually all of the remaining transmitting equipment with exception of the peak limiting amplifier. This cabinet contains the third and final buffer stage, the radio frequency power amplifier, the modulator, the driver amplifier, bias supplies, main power supply, complete relay control equipment, control panel, metering equipment and other required components.

The third buffer stage employs a type RK47 tube which is directly interchangeable with a type 814 tube if desired. This stage is provided with both grid and plate meters as well as grid and plate tuning. Excitation to this stage is obtained from the 25-A frequency control panel. The grid coil is contained in a monel case mounted on the top chassis and is tuned from this point at time of installation. Plate tuning is from the control panel. No neutralization is required for this stage.

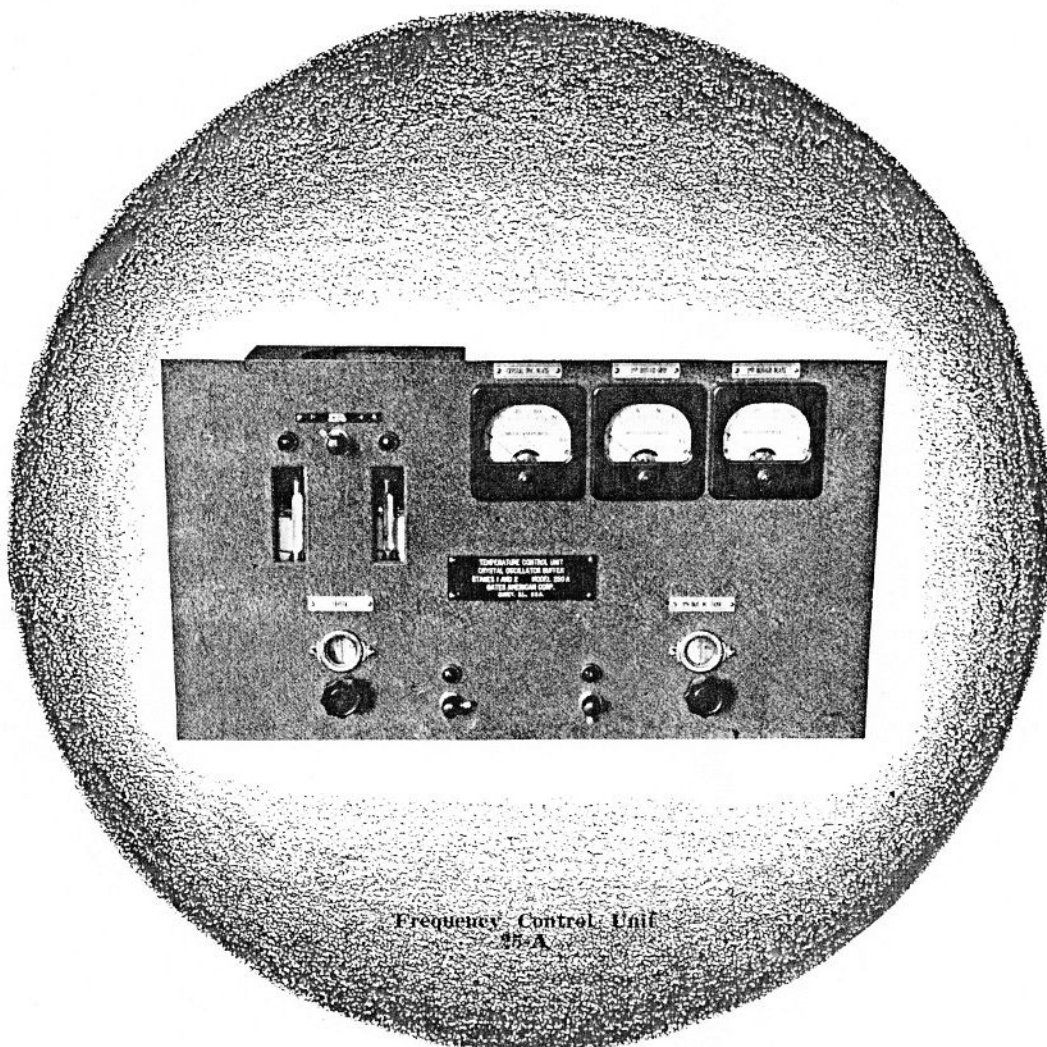

Frequency Control Unit
25-A

The final radio frequency stage or the power amplifier contains two type 805 tubes for 100-250 watt operation or two type 838 tubes for 100 watt operation only. This stage operates in push pull. Tuning of this stage is controlled from the main control panel as well as neutralization. The design of the main transmitter layout is such that all tuned devices are in the exact electrical circuit rather than in the exact mechanical circuit. This is derived by use of geared flexible shafts for tuning from the control panel. As a result an efficiency of 72% minimum may be expected from the 250-A equipment which is among the highest ever obtained from a radio broadcast transmitter.

Harmonics are suppressed by the combination balanced push pull R. F. amplifier and the provision of an isolated antenna tuning equipment which is link coupled to the tank coil in the power amplifier stage. Both units are mounted in the main transmitter cabinet. Transmitter is provided ready to couple either to a direct coupled antenna or transmission line.

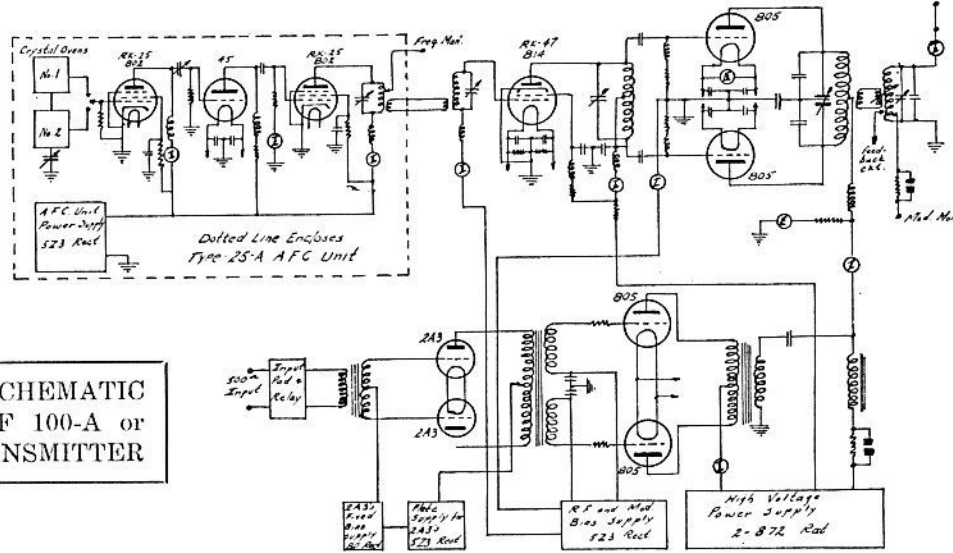

GENERAL SCHEMATIC
DIAGRAM OF 100-A or
250 - A TRANSMITTER

Tuning in the antenna circuit for exact power output is derived through a tuning link or variable link between the tank coil and antenna coil. This method assures the best possible transfer of radio frequency energy without affecting the tuning in any other part of the circuit, harmonic content or balance in the push pull stage.

Metering provided consists of power amplifier grid, power amplifier plate current, power amplifier plate voltage, antenna current, and filament volts.

Power change in the 100-250 watt model is by means of a single key which, when changing from 250 to 100 watts, reduces plate voltage, audio excitation and modulation monitor excitation all in one operation by means of relays.

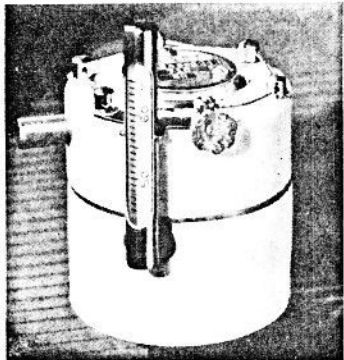

Temperature Control Oven

The modulator employs two type 805 tubes in the 100-250 watt unit and 838 tubes in the 100 watt unit only. High level class B modulation is employed with full 100% modulation possible by using only 66% capacity of the modulator, assuring low distortion content, improved regulation and long tube life. Modulator plate current meter is provided.

Though the modulator tubes in either case are zero bias design a small amount of bias is provided so that the tubes may be kept in perfect balance at all times by means of a balancing control provided.

The driver amplifier uses a pair of 2A3 tubes in push pull fixed bias providing two and one-half more times undistorted output than required to fully drive the transmitter for 250 watts output. The power supply for the driver amplifier is a separate unit to that of the main power supply as is the radio frequency and modulator bias supply. The transmitter is protected with a bias relay preventing

turning on any high voltage or automatically cutting the high voltage in case of bias supply failure.

The main power supply consists of a pair of 872 tubes in single phase full wave delivering 1250 volts at 1 ampere or 25% more than required for 250 watt operation, assuring power regulation of from 3 to 4%. Transformers and filter chokes are of heavy design fully cased in cast housings providing complete shielding and low temperature rise over long heavy schedules.

Starting equipment and protective devices are as fine and complete as money can buy. Complete time delay starting, push button control, circuit breaker control in the main primary line and plate overload relay control in the secondary high voltage line is part equipment. Door interlocks for the two front and one rear door are handled by heavy approved switches that will not give trouble. No circuit, either low or high voltage, is handled direct from the



Rear View Frequency Control Unit

control panel, all being done by relays. No fuses are required because of the primary circuit breaker provided.

The main transmitter cabinet is as fine from a mechanical and appearance standpoint as it is electrically. The top inside chassis is of genuine monel metal. Complete frame construction is of aluminum assuring better electrical properties and lighter shipping weight. There is no part in the entire transmitter that cannot be reached quickly for servicing when required.

The outer design provides a galaxy of colors including terra cotta, steel gray, natural aluminum, black control devices and monel metal corners and meter frame trims. The 250-A is smart and commercial in its eye value immediately creating an atmosphere of domination in high quality. Size 72 inches high, 28 inches wide, and 20 inches deep, over all.



The Audio Compressor Speech Unit

THE AUDIO COMPRESSOR

Not until the announcement of the Gates American 250-A Transmitter has any broadcast transmitter been supplied as standard complete with peak limiting amplifier. This is a separate panel as shown in the illustration and with its use allows a full 3 Db. more average modulation than would be possible without its use. This means without question approximately double signal output over that of transmitters not using a peak limiting type speech equipment. As a result it can be said with close accuracy that at 250 watts the 250-A Transmitter would be quite comparable to any 500 watt transmitter not using a peak limiting amplifier or at 100 watts quite comparable to any 250 watt transmitter without peak limiting amplifier. This is not just a matter of theory but in actual practice has even proved more absolute as a peak limiting amplifier acts as a means of increasing the average signal level which in the average case is a more noticeable increase than a carrier increase.

The 17-B Audio Compressor has three all push pull stages (note that every stage from audio input to the final radio frequency power amplifier is push pull) and employs a regulated design power supply assuring accurate compression at all times regardless of line voltage. The differential bridge type of compression is employed and not electronic, the latter inducing serious distortion into the circuit where tube condition is not to the extreme in perfectness.

The 17-B is finished in steel gray and may be rack or desk mount. Panel size is 12 $\frac{1}{4}$ inches by 19 inches with vertical rear design. Tubes employed: two type 6J7, two type 6F6, two type 6C5, one each type 80, 6C6 and 2A3.

Characteristics

	250-A	100-A
Carrier Output	100/250	100
Frequency Range	550—1600 Kc.	550—1600 Kc.
Power Supply	Normally supplied for 110 volt, 60 cycle, single phase. 220 volt on order.	110 volt, 60 cycle, 220 volt on order.
Power Consumption	250 watt—1700 watts 100 watt—1300 watts	1250 watts
Radio Frequency Stability	± 10 cycles	± 10 cycles
Radio Frequency Harmonics	Below .05%	Below .05%
Modulation	Class B; full 100% High Level	Class B; 100% High Level
Audio Input 100% Mod.	-10 Db.	-10 Db.
Average Program Level	-14 Db.	-14 Db.
Audio Frequency Response	$\pm 1\frac{1}{2}$ Db. 20 — 12,000 cycles	
Audio Distortion (50 - 7500 cycles)	85% Mod. — 2.5% Rms 100% Mod. — 3.5% Rms	
Noise Level	More than 60 Db. unweighted below program level	
Operation Costs	At power cost of 2c per Kwh, and 3,000 hour tube life, for 250 watt operation, approximately 9 $\frac{1}{4}$ cents per hour.	

Tubes

	250-A	100-A
RF:	2—RK25 or 802 1—45 1—RK47 or 814 2—805	2—RK25 or 802 1—45 1—RK47 or 814 2—838
AF:	2—2A3 2—805	2—2A3 2—838
Power Supply:	2—872 3—5Z3 1—80	2—872 3—5Z3 1—80
Compressor:	2—6J7 2—6C5 2—6F6 1—6C6 1—2A3 1—80	2—6J7 2—6C5 2—6F6 1—6C6 1—2A3 1—80

The
GATES AMERICAN CORPORATION, Quincy, Ill.

A Gates Enterprise

Gates 21 and 22 Series

Antenna Tuning Units

and

A New Tower Lighting Choke Cabinet

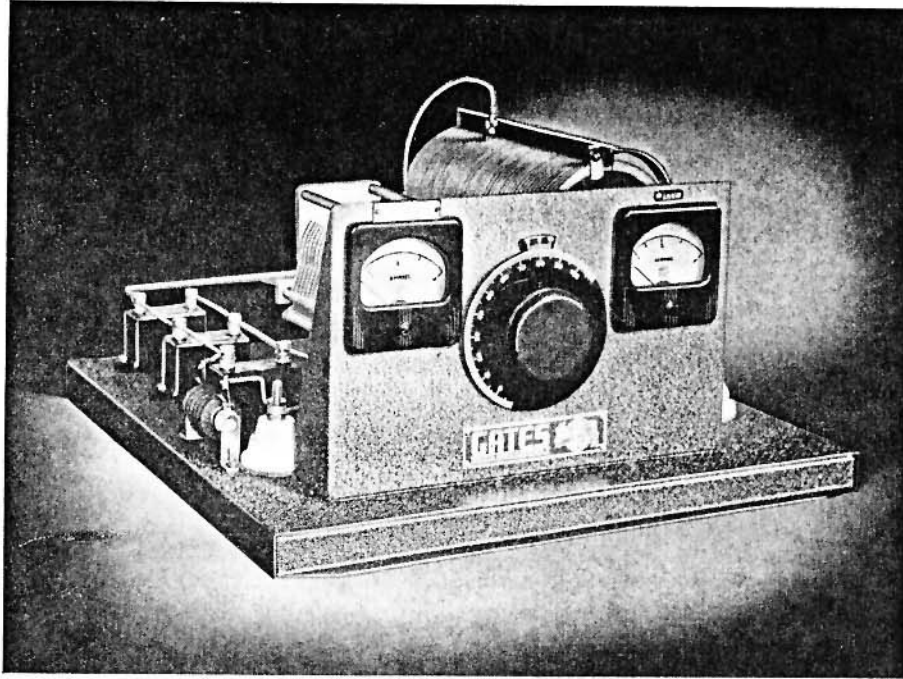

High Efficiency

Weatherproof

*Low Harmonic
Emission*

A complete new antenna tuning equipment offered in models for series or shunt fed radiators.

full detail on next page

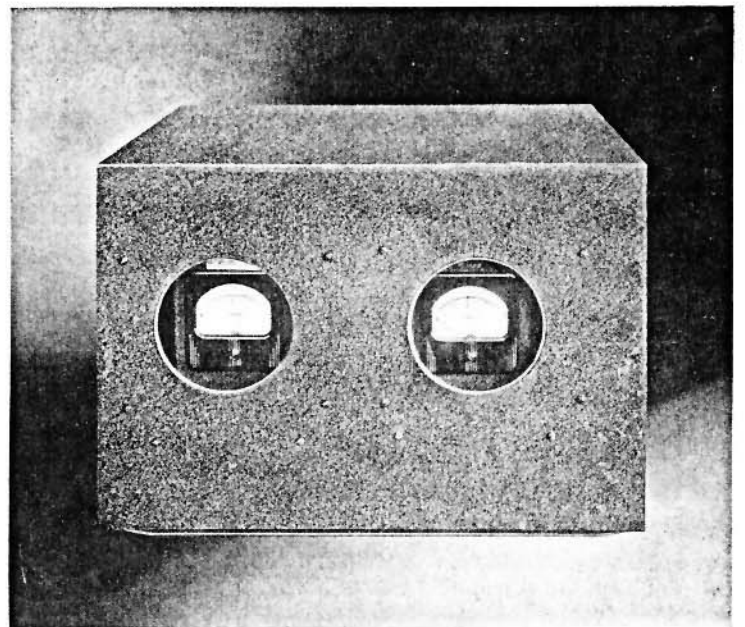

GATES 21 SERIES ANTENNA TUNING EQUIPMENT

the realm of modern radio broadcasting one of the most important items in the entire broadcasting plant is the antenna tuning equipment, as it is at that point that energy may be either conserved or destroyed. Likewise improper antenna tuning equipment will often act as a harmonic generator which not only is contrary to good engineering practice but likewise reduces the strength of the fundamental signal.

In the 21 Series antenna tuning units are offered two models for series feed and two models for shunt feed, both being the last word in engineering design and electrical construction.

GENERAL DESIGN: The illustrations indicate quite clearly the general idea followed in design and construction. All equipment is mounted on a cold rolled steel base plate finished in baked hard enamel to withstand varied temperatures without cracking or peeling. Over the top of this slips the cover or housing which is 11" high, 16" wide and 20" deep overall and which is resistance and seam welded with window openings for meter observations well protected by glass puttied around all edges for complete waterproofing of the entire assembly. Cover likewise is finished inside and out with a heavy coat of baked enamel. Coaxial or open line transmission systems terminate at stand off bushings feeding through the bottom of the cabinet or if desired plenty of room is provided to insert any type of coaxial cable coupling that might be used.

TYPES 21A and 21B—These units are the same other than the 21A is for a maximum power of 350 watts while the 21B is for a maximum power of 1250 watts. Larger powered units are available with prices on request. The 21A and 21B are designed to coupled from a 73 ohm coaxial cable, a 2 wire open line or a four wire transmission line direct to a series fed or commonly known as an insulated vertical radiator. They are available for any frequency from 550 to 7600 Kc. with the broadcast model able to tune any frequency from 550 to 1600 Kc. This is done by a series of fixed capacities and one variable capacity which may be strapped into a number of combinations for proper frequency which is given in a chart sent with the instructions. Antenna coil proper is of heavy edgewise wound copper strip cadmium plated. Clips are provided for varied coil adjustments. Antenna tuning is aided by the supply of two 3" meters fully F. C. C. approved that read line current and antenna current proper. The general design produces a configuration of a low pass filter providing unusual low harmonic emission when used with a properly designed transmission line and of course correctly tuned. Bleeding choke is provided for static drain.

TYPES 21C and 21D—These antenna equipments are for shunt fed antennas or the non-insulated type. They vary widely in construction to that of the series fed units, but are of course equally efficient for the shunt fed type of radiator. Fundamental construction consists of an oversized tuning condenser in series with the feed line and antenna meters supplied. Size and general appearance is the same as the 21-A and 21-B. Model 21-C is for a maximum power of 350 watts shunt fed and 21-D is for a maximum power of 1250 watts shunt fed.

INFORMATION REQUIRED WHEN ORDERING: If possible state antenna tower resistance and of course operating power (maximum). If resistance of tower is not known then state height. Regardless of system now employed advise present antenna current (maximum) and line current of line if used. New stations should specify frequency and height of tower also.

Prices

Model 21-A —Series feed tuning unit for maximum power of 350 watts. Complete and ready to install	-----	\$97.50
	Code Word (YUHUX)	
Model 21-B —Same as above, only for maximum power of 1250 watts	-----	\$147.50
	Code Word (YUHW0)	
Model 21-C —Complete shunt feed antenna tuning unit for maximum power of 350 watts. Ready to install	-----	\$82.50
	Code Word (YUHZY)	
Model 21-D —Same as 21-C, only for maximum power of 1250 watts	-----	\$132.50
	Code Word (YUIFS)	

TOWER LIGHTING CHOKE UNIT

For series feed antennas a weather proof choke assembly is required in the 110 volt lighting line to insulate the R. F. in the tower from the light line. This is available in a unit to match the tuning equipment and built to attach to the tower. Stands 22" high, 6" wide, and 6" deep. Consists of a double wound choke coil on a 3x18" tubing to withstand 2000 watts current without heating. Mica by-passing condensers are provided on the input side of the equipment and input and output feeds are through insulated weather proof bushings at the bottom of the cabinet. Entire unit is of cold rolled steel, finished in baked hard enamel.

Model 22-A —Tower Lighting Choke Cabinet. Ready to install	-----	\$27.50
	Code Word (YUIGT)	

RELAX!

and have

ONE CYCLE ACCURACY--BY USING

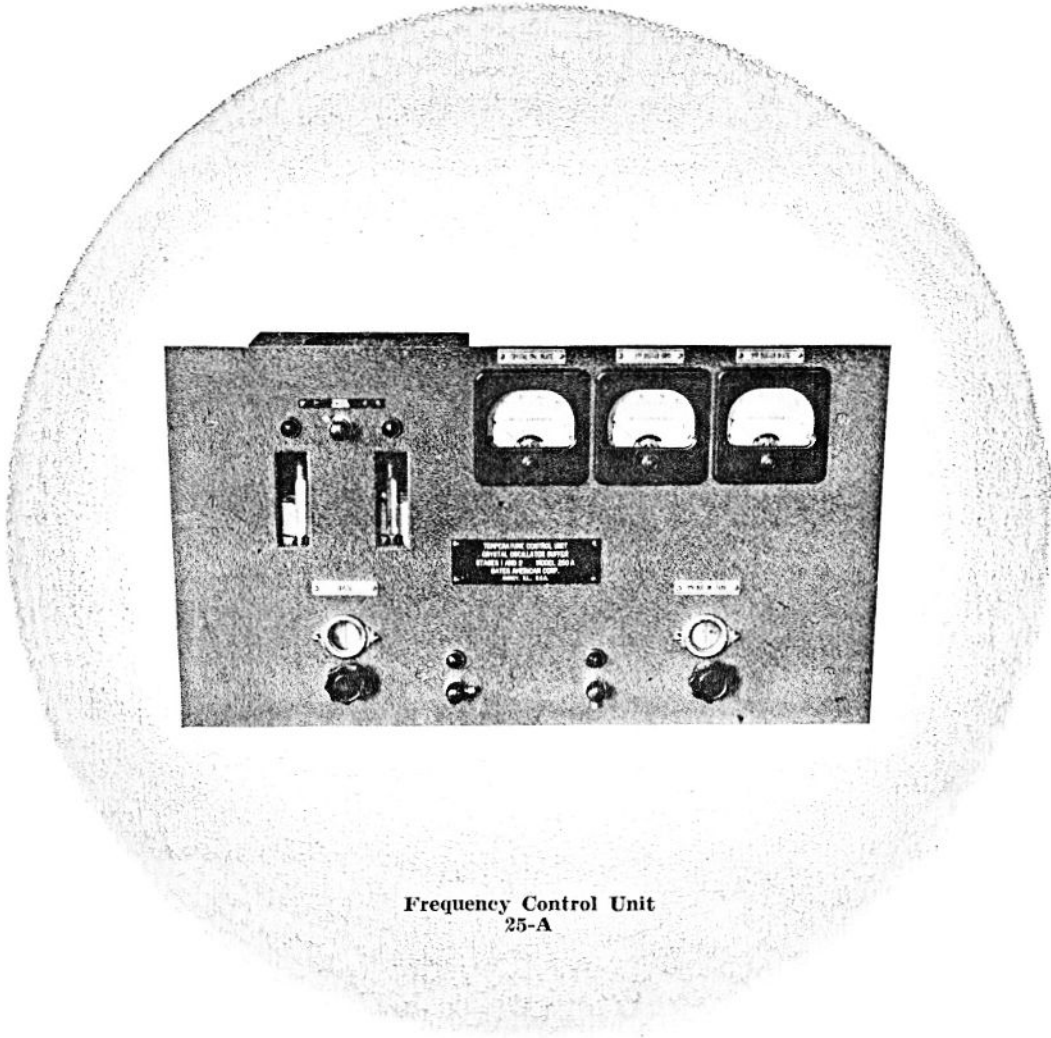

Frequency Control Unit
25-A

Gates American Corporation

Model 25 A

FREQUENCY CONTROL UNIT

Fully F. C. C. Approved

Please turn the page

THE 25-A FREQUENCY CONTROL UNIT

is complete

There are few, if any, frequency control equipments on the market as complete as the Gates American 25-A. There are none with such a galaxy of features and fully F. C. C. approved that are as moderate in price yet so fine that it boasts of customers in every rank and file of the industry.

The 25-A has oscillator, first and second buffer stages, power supply, two separate temperature control ovens equipped with the latest AT cut crystals, complete Weston metering, provision for frequency monitor take off, link coupled output for easy coupling to succeeding stage of transmitter, crystal change over switch, indicating lamps for each temperature chamber, individual power cut off switches for oscillator and buffer stages and tuning controls for both the oscillator and final buffer stages. Most certainly the 25-A is complete. It need only be placed in the rack, connected to the transmitter and monitor and it is ready to go. As the 25-A carries full F. C. C. approval no long delays are had before installation can be made.

Material Features

The 25-A is constructed of only the finest materials to assure freedom from breakdowns and continual operation year in and out. Look over these features:

- 1 Oscillator stage utilizes commonly known untuned circuit or this stage is tuned at the factory to your frequency, assuring stability under all conditions. A small grid tuning capacity is provided to obtain a frequency variance within 50 cycles.
- 2 Quick heat cycle ovens with carefully ground AT cut crystals are supplied. Two complete ovens with crystals standard equipment.
- 3 Isolating type first buffer stage assures frequency stability regardless of condition existing in succeeding stages of the transmitter. This is an exclusive Gates American feature.
- 4 No neutralizing employed as first buffer is self neutralized and second buffer is screen grid design.
- 5 Interchangeability of tubes. Either type RK25 or 802 tubes may be used in oscillator and second buffer.
- 6 Heavy duty power supply, oil filled condensers throughout and guaranteed cool operation under heavy schedules.
- 7 Weston metering in oscillator plate and second buffer grid and plate. No midget meters, full 3 inch.



Rear View Frequency Control Unit

The 25-A Carries a Triple Frequency Check

... for your assurance

Here is part of the service you obtain before delivery of the 25-A Frequency control unit to your station. First, each of the crystals is checked in the ovens by the elaborate apparatus of the manufacturer of the ovens and crystals for Gates American which is at the Bliley Laboratories in Erie, Pa. Here each unit is tested for several hours to make certain that no frequency inaccuracy or drift prevails.

These crystals with ovens are then shipped to Gates American where they are given a second and complete identical test as operated in the 25-A as a complete unit. Crystal current is checked against frequency. It is checked on low and high line voltages to make certain this will not affect the thermostats either in operation or sticking.

After the 25-A has been fully tested and pronounced okay by Gates Engineers it is tested for three days for frequency drift under varied line voltage and heat conditions and not released until you can completely relax as to your frequency accuracy when the 25-A is installed in your station.

This triple check is for your relaxation after installing the 25-A that it can and will stay on frequency.

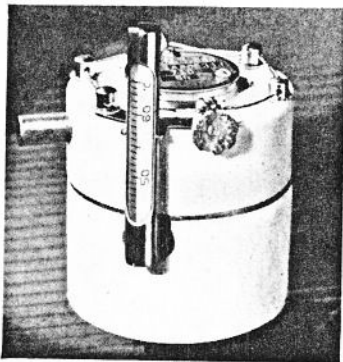

One of the two 25-A Crystal Chambers

Don't Gamble with your frequency stability

There's no odds when the Gates American 25-A is used.

Are you revamping the transmitter? Make the 25-A a part of your program.

Are you depending on one crystal? The 25-A has two.

Please turn the page

General Description 25-A

The 25-A equipment is constructed for standard rack mounting having a panel size of 19 inches by 10½ inches and finished as standard in baked black ripple enamel unless supplied with Gates American transmitters where the finish is gray. Other finishes may be had to match customer's other equipment such as telephone black, steel gray, platinum gray and tan. Chassis size extends 14 inches to the rear and 16 inches wide. Bottom of chassis removes by self tapping screws for servicing if required. Crystal chambers are protected by a removable shield cover (from the top) and oscillator tube is enclosed in this same shield but may be removed through a hole in the top of the shield thus making unnecessary removing the shield to remove the tube.

A type RK25 (interchangeable with type 802) tube is used as oscillator and second buffer. A type 45 tube untuned as first buffer and a type 5Z3 as power rectifier. Power supply is fused, uses oil filled condensers and designed for cool operation. Standard equipment is for 110 volts 50-60 cycles, but other voltages and frequencies may be had at \$5.00 additional.

The complete crystal oven with crystal is of the plug-in type, quick heat cycle type and will hold the frequency under all conditions within 3 cycles or less of the assigned frequency. The 25-A may be had for any frequency from 525 to 9000 kilocycles covering either standard broadcast or high frequency broadcasting stations.

Tuning controls are provided for minor frequency adjustments in the oscillator stage (approximately 50 cycles) and second buffer plate tank tuning. Output is link coupled but may be had capacity type coupling at no extra cost where specified. Front panel switches are provided with adjoining pilot lights with one switch as the master switch and the second to turn off the plate voltage from the buffer stages so the isolated tuning of the oscillator stage may be made if desired when the transmitter is off the air.

Complete metering is provided with full size Weston Pattern 301 square case meters in the oscillator plate, second buffer grid and second buffer plate. All meters and controls are plainly marked.

In the 25-A the purchaser has a complete self contained unit up to the third buffer stage. For those using composite transmitters it is ideal, eliminating the need for lengthy approval data as well as the time for designing the most touchy part of the entire transmitter. For those stations having factory built transmitters that could improve on frequency stability or lack proper excitation the 25-A is the answer. A full 7 watts of excitation is obtained with the 25-A equipment.

At the moderate cost of the 25-A equipment no broadcasting station can afford to take chances with being off frequency and with the elaborate construction of this equipment no broadcasting station need pay more.

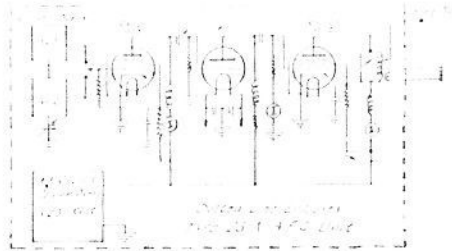

Price

\$373.00

Code Word (YUHAS)

Manufactured by

GATES
QUINCY, ILLINOIS, U.S.A.

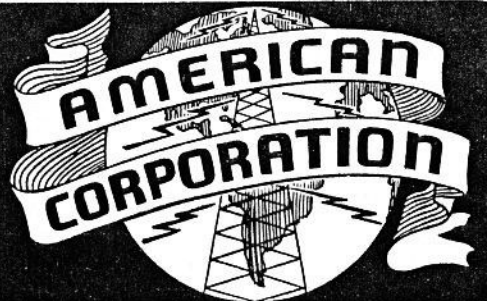

The **20 SERIES CONSOLE**

Is the most talked about
Speech Equipment on the
market today.

Because

It carries guaranteed flat
response from 30 to 15,000
cycles.

The distortion content and
noise level is lower than
ever before.

Its beauty and massiveness
is beyond description.

Facilities exceed in many
cases the most elaborate
rack type system.

And because all of these is
possible at a very low in-
vestment.

A banquet in features awaits
every 20 Series Console user.

● *Turn the page and
convince yourself.*

THIS SPEECH CONSOLE IS A LISTENER PRODUCER

This letter is one instance

WJPR
WISE
WEDC
KVAN
WSBC
WJRD
KRLH
CMW
SUI
KFDY
WOKO
WLNH
CHNS
CJIC
CKTB
WJBW
KBTM
CKPC
CFQC
TIPG
EMB
HJIABB

VANCOUVER RADIO CORPORATION
VANCOUVER, WASHINGTON

Gates Radio & Supply Company,
Quincy, Ill.

Gentlemen:

Radio Station KVAN went on the air this week with all new Gates equipment, part of which was the 20 Series Console of your manufacture. As you know Vancouver is just across the river from Portland where there are six fine radio stations. Consequently a new station must be able to compete in every way and quality of transmission is highly important.

On our first days operations we received over 200 calls complimenting us on our tonal quality, making mention of the full rich musical quality obtained from our transcriptions.

We, of course, can only attribute these results to the Gates Speech Equipment and the 20 Series Console. As the writer is an old timer in broadcasting, it goes without saying, that 200 compliments in one day on tone quality alone is almost a record of some sort.

Yours very truly,

VANCOUVER RADIO CORPORATION
Walter Read.

*More Listeners Means More Dollars
For You and Your Advertisers.*

A Word About Equipment Beauty

Beauty is a word that has many meanings. A beautiful piece of equipment would mean to the Chief Engineer an instrument that had quality that was a pleasure to behold, performance that is unquestionable and reliability that makes him the minimum of trouble. To the studio director a beautiful instrument must be gorgeous to see, have modernistic flash and must immediately command attention of the visitor and artist as worthy of doing a good job of the artist's best effort.

A beautiful instrument to the manager of the radio station is an instrument that will produce profits through better broadcasting which includes better tonal quality, controls for unrepulsive handling and facilities to handle all of the station's requirements with extra to spare.

We are convinced, not from our own standpoint, but from the large number of unsolicited commendations we have received from engineer, director and manager alike that the 20 Series Console meets all requirements for these three executive branches of radio as being beautiful.

**Five Universities
use
The 20 Series
Console**

University of Iowa

State College of S. Dak.

Michigan State

Virginia Pol. Institute

New York University

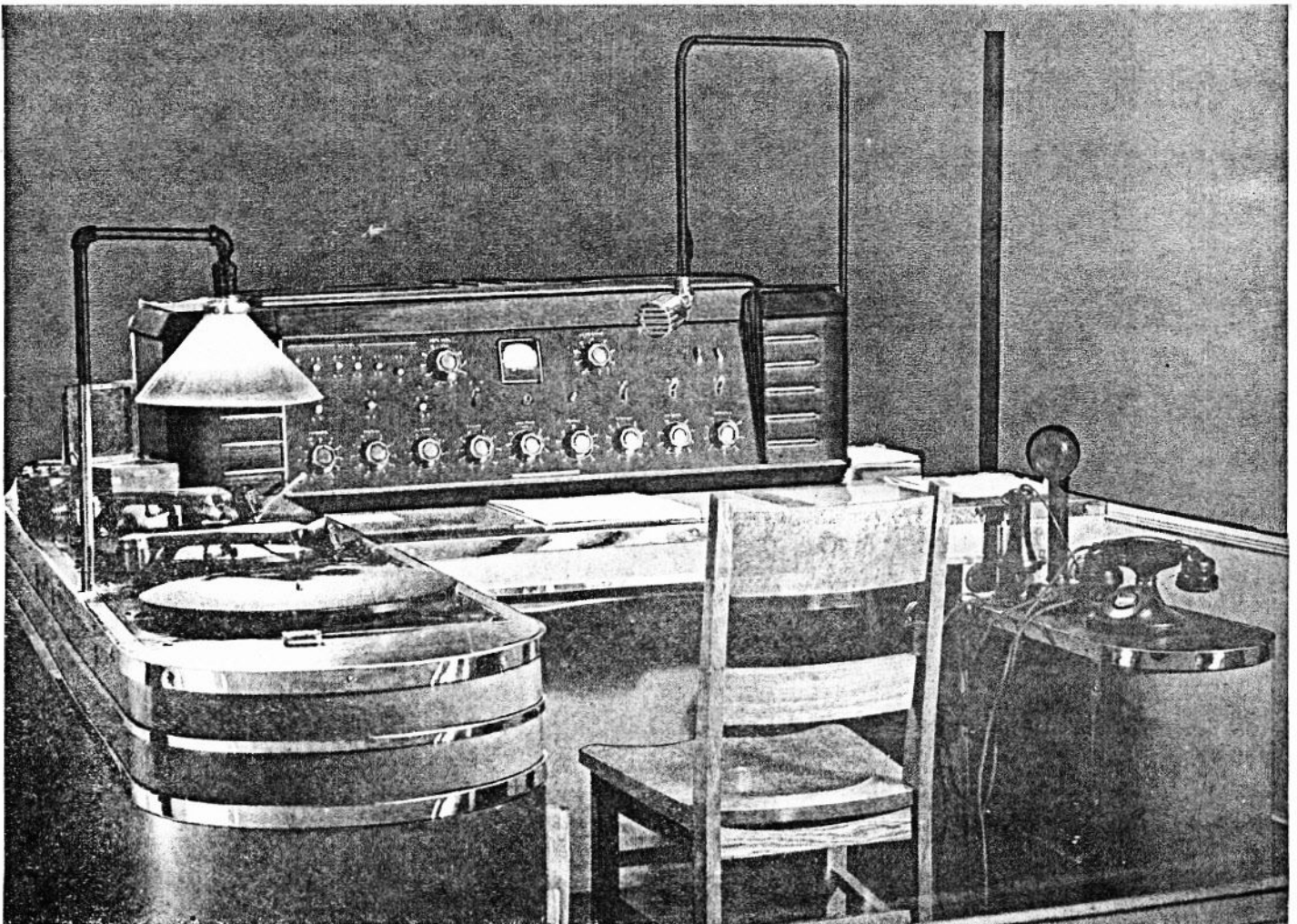
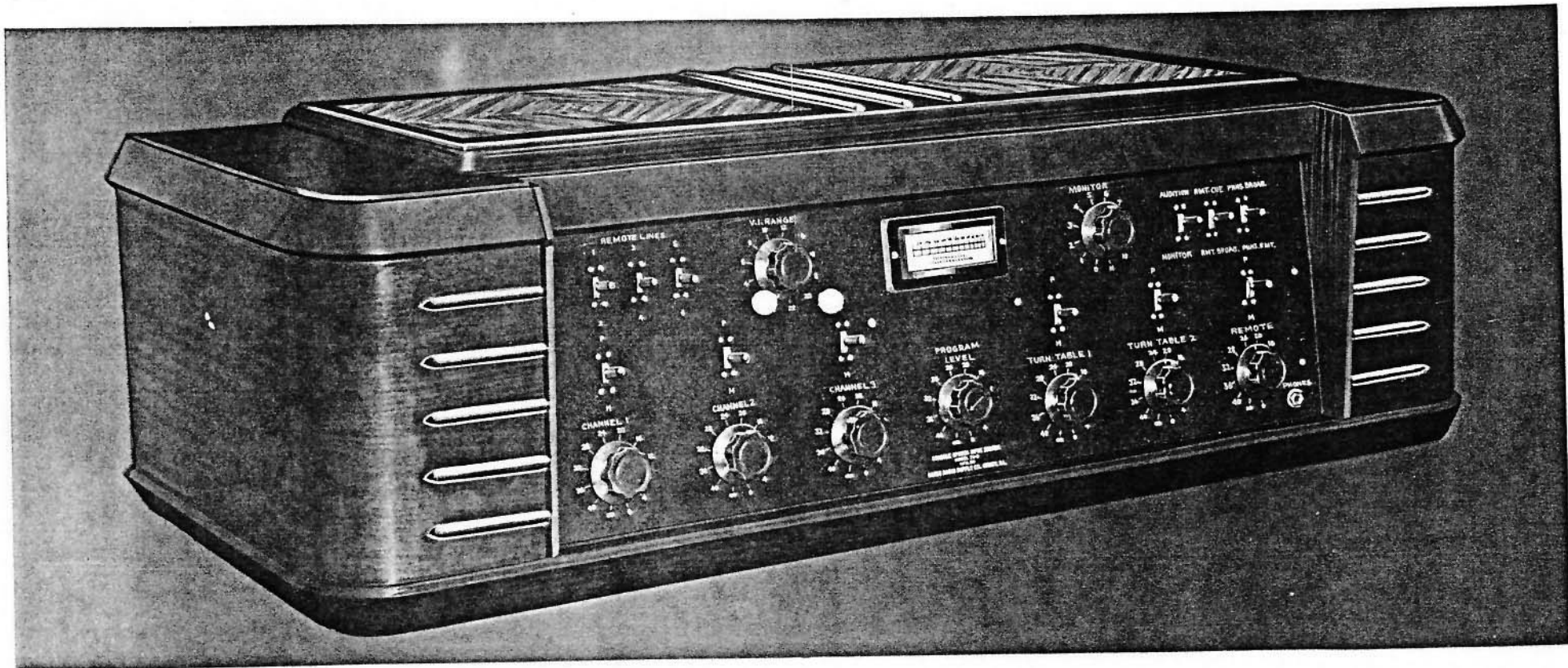

Fig. 2—Any broadcasting station will feature such a layout as this because it reflects Equipment Progression.

THE
20-SERIES
SPEECH CONSOLE_____



NOTE—When looking at this illustration, remember the massive size of 48 inches long. Lettering on panel has been slightly enlarged for illustration.

TECHNICAL DESCRIPTION

Before getting into the usual run of response curves, impedances and so on just a word about the lay out. We should mention that no trick circuits are used to save money. You know, there are a few equipments on the market that employ pads instead of transformers at certain points in the layout as it is cheaper and of course one can always skimp by using cheap relays, cheap meters and other parts but that is not so with the Gates Console. Just for example we are using linear standard transformers for each of the ten transformer positions. Eight of these transformers have heavy cast metal cases, static shields and hum bucking windings with triple alloy shields.

Mixing controls are all Daven first quality attenuators with bronze contacts for long wear. The Db. meter is of special design for the Gates Console having a cobalt magnet for high speed action, yet not so fast that it can not be seen. Illumination is from the rear through a transparent scale which means no shadows. The relays are Guardian Automatic, the same type as used in automatic telephones where results must be positive every time. Oil filled filter condensers are used and no electrolytics other than in low voltage bias circuits. A three section filter assures perfect direct current to tube plates and no hum. We could go on about parts quality but the above gives you a good idea that the Gates Console has quality.

A word about lay out. In the Gates Console the unit system is not followed as units mean complicated construction and complicated design does not fit in the console picture. As a result one large chassis holds all of the equipment. Yes it makes it a little harder for us to construct but its easier for you to service because you need only slip the bottom off the cabinet to reach every last part in the job down to the smallest resistor or condenser. You do not need to be a sleight of hand artist to clean mixing controls or make any usual maintenance routine with the Gates Console. Let's get into the technicalities.

PRE-AMPLIFIERS—Three are supplied in the 20-B, four in the 20-C and five in the 20-D. Each pre-amplifier has a mixing control and key associated. Each pre-amplifier is complete in itself though of course on the one common chassis. By complete we mean it has an input and output transformer with input impedance matching for 30, 200, 250 or 500 ohm microphones. A 6F5 tube is used in each pre-amplifier. The output feeds into the mixer which may be keyed into either the program or audition amplifier channels. Input is connected through the latest type Hubbell twist lock connector which is supplied for each pre-amplifier.

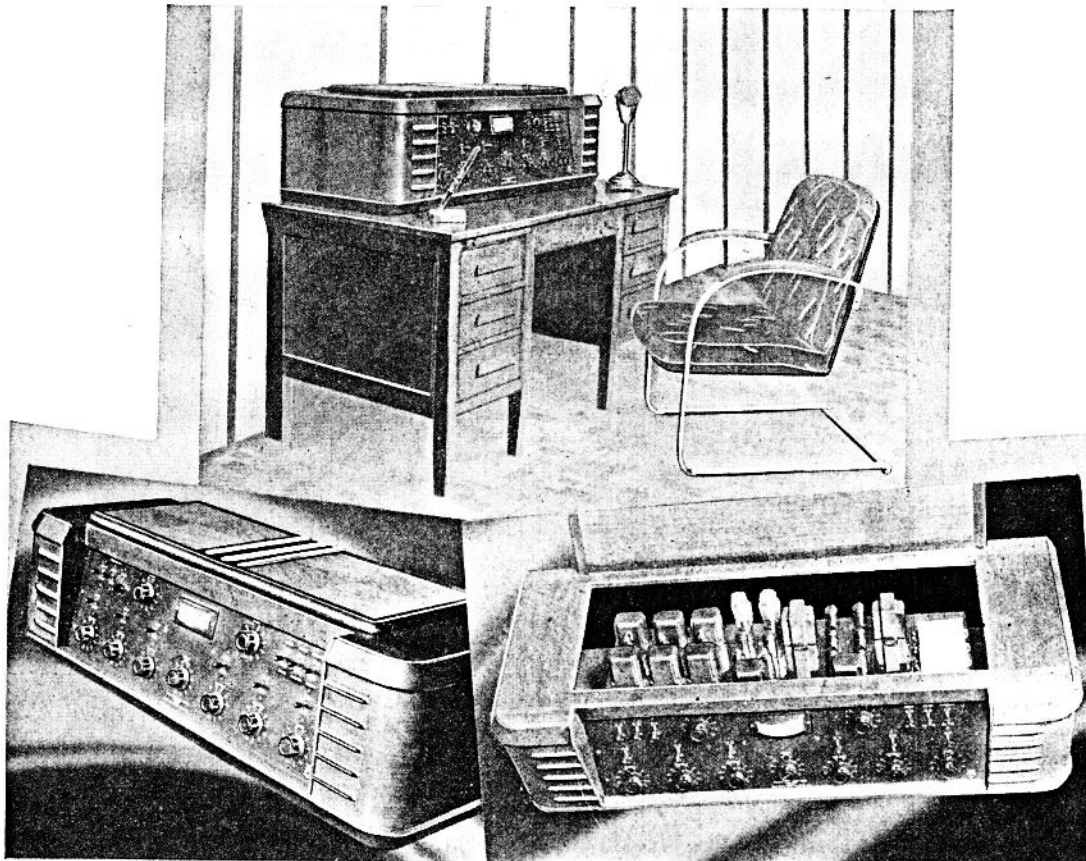

Fig. 3—Angle shots to show 20 Series Completeness

MIXING FACILITIES—As previously stated there is a mixing control for each pre-amplifier provided plus two mixing positions for turn-tables and one for remote circuits which of course obtains its input source from the remote circuit keys (see remote keys). Thus in the 20-B which has 3 pre-amplifiers there are six mixing positions, namely pre-amplifiers 1, 2 and 3, turn table 1 and 2 and remotes. In the 20-D we have seven mixing channels as this model as four pre-amplifiers and in the 20-C we have 8 mixing channels as there are 5 pre-amplifiers.

Each mixing control feeds into a key which makes possible connection of any mixing position into either the program amplifier or audition amplifier or any number of mixing positions may be used for broadcasting with the balance for auditions if desired right while on the air. These keys also control the relays which operate the loud speaker circuits to cut off when adjoining a live microphone to prevent feed back (see relays).

PROGRAM AMPLIFIER—Both the program and audition or monitor amplifiers are 3 stage units, high gain and all push pull, the latter assuring the full advantages of hum-free operation and full use of feed back which greatly reduces distortion content. The program amplifier uses 6J7 tubes in the first stage, 6C5 tubes in the second stage and 59 tubes in the third stage. Output is 500 ohms which feeds the broadcast line and through a pad as optional (through key) to the monitor amplifier for monitoring off the broadcast loop. A master gain control of wiping contact Daven design is used. This amplifier with inverse feed back and high fidelity design is one of the most up to date known today.

AUDITION OR MONITOR AMPLIFIER—This amplifier is essentially the same as the program amplifier only employs 6C5 tubes in the first and second stages and 6F6 tubes in the output stage supplying a full six watts to the loud speakers. This amplifier may be used as a spare in case of program amplifier failure. Its input connects to a key which selects its use as either an auditioning amplifier from the mixing system or a monitoring amplifier off the broadcast line. Its output feeds to four loud speaker provisions, three of which are controlled by relays.

RELAYS—Three are supplied which operate from the mixer keys controlling the microphone or pre-amplifier circuits. Each relay is of the make before break type preventing pops at time of operation and dummy resistors operating from the relay contacts keeps the loud speaker line constant impedance at all times. Where more than three pre-amplifiers are used in the case of the 20-D or 20-C the relay circuits parallel two keys or are operative from two mixing positions instead of one. For example, if 4 pre-amplifiers were used mixing positions 1 and 2 would each control an individual relay with 3 and 4 controlling the same relay. Provision is also made for six volt signal lights for three studio positions. Relays operate from a D. C. rectifier provided on the main power supply.

OUTPUT METER—Square case type slightly altered from that of photo. (See Fig. 2 for exact type). Scale —10 to +6 Db. .006 watts at zero reading. Fully illuminated from rear through transparent scale and provided with range control to left of meter. Reads output of program amplifier to broadcast loop and of proper speed to synchronize with Gates limiting amplifiers or most types in use today. Of high speed type. V. U. meter may be had at slight extra cost where desired and is standard Weston Model 301.

TURN TABLES—Two mixing positions provided also selectable into either program or audition amplifiers. Full Daven wiping contact design.

REMOTE MIXING—Six remote positions may be handled on the standard equipment controlled by three remote input keys

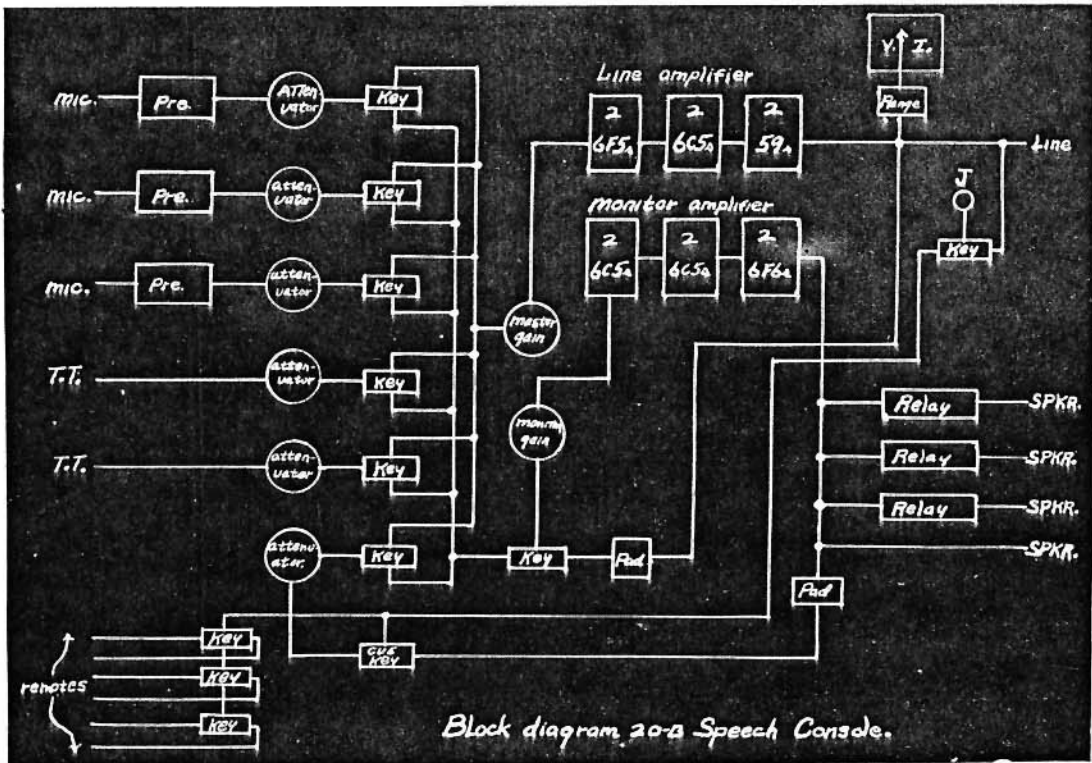

20-B Block Diagram. 20-C has one added pre-amplifier and mixer with key. 20-B has two added pre-amps, mixers and keys. Remote isolation transformer omitted from drawing in error.

in the upper left corner. These feed to the remote cue key in the right hand upper corner. This key allows by connection at one position to the output of the monitor amplifier (through a pad) for sending the remote cue to the remote operator. When this key is at the other position the remote circuit is set up for broadcasting through the remote mixing control. This control like all the rest may be connected by means of another key to either the program or audition amplifiers, thus if desired, the remote program may be checked in advance over the studio speaker system without putting it on the air.

HEAD PHONE KEY—Provided to connect head phones for either listening off the program amplifier output or the remote circuit.

MONITOR KEY—Provided to connect the monitor amplifier either for auditioning from any mixing channel or off the broadcast loop for general speaker monitoring and program distribution throughout the studios.

MONITOR CONTROL—Provided for volume adjustment on the monitor or audition circuit.

POWER SUPPLY—A separate unit not shown in illustration. Supplies all filament and plate voltage to the console as well as 6 volts D. C. to relays and studio signal lights. Uses heavy parts, oil filled condensers and built for 24 hour a day service.

SPECIAL REQUIREMENTS—These equipments are designed as standard to fill the most called upon needs of broadcasters. However slight alterations can be made without greatly effecting cost or delivery time. Different mixer impedances, output impedances or other similar changes can be provided where required. If slight changes are needed to meet your particular requirements just mention them when ordering.

TECHNICAL

TUBES USED—Model 20-B uses three 6F5, two 6J7, two 59, two 6F6, six 6C5 and one 5Z3.

Model 20-D, add one 6F5.

Model 20-C, add two 6F5.

MIXER—500 ohms throughout (other impedances where required).

MICROPHONE INPUT—Variable from 30 to 500 ohms, all commonly used impedances.

LINE AMPLIFIER OUTPUT—500 ohms.

MONITOR OUTPUT TO SPEAKERS—500 to 1500 ohms.

OVER ALL GAIN—Pre-amplifier input to line amplifier output including all circuit losses, 105 Db.

OVER ALL GAIN—Same as above only using audition amplifier instead of program amplifier, 100 Db.

LINE AMPLIFIER GAIN—84 Db.

MONITOR AMPLIFIER GAIN—79 Db.

Maximum output to broadcast loop not exceeding .5% distortion content, plus 22 Db.

Maximum output to broadcast loop not exceeding .3% distortion content, plus 15 Db.

FREQUENCY RESPONSE (guaranteed) flat within plus or minus $\frac{3}{4}$ Db. from 20 to 13,500 cycles.

REMOTE CIRCUIT INPUTS—500 ohms.

NOISE LEVEL—62 Db. below zero.

Prices

Model 20-B —Complete with tubes including 3 pre-amplifiers and as described with power supply and ready to operate. Code word (YUDVY)	\$595.00
Model 20-C —Same as above but with 4 pre-amplifiers and one added mixing channel to correspond. Code word (YUFWY)	\$620.00
Model 20-D —Same as 20-B but with 5 pre-amplifiers and two added mixing controls to correspond. Code word (YUGAR)	\$650.00

Add \$10.00 for odd cycle or voltage other than 110 volt 50-60 cycles. For V. U. Meter instead of Db. meter add \$18.00.

Size and Cabinet Design

Size is 48" long, 18" deep and 14 $\frac{1}{2}$ " high. Top hinges and bottom is removable. Back is open. Cabinet of genuine walnut with inlaid top of foreign Rakuda wood all finished in natural color with lacquer overlay to prevent marring. Stainless steel end and top trims provide modernistic trimmings. Corners rounded and tapered and panel slopes at 12 degree angle. Cabinet fully reinforced, steam formed; will not check or discolor with age.

GATES RADIO & SUPPLY CO.

MANUFACTURING ENGINEERS SINCE 1922

QUINCY

(Cable Address Gatesradio)

ILL., U. S. A.



MODERN TRANSMITTING PLANT
LOCATED NEAR STATE COLLEGE, ARK.

MEMBER NATIONAL ASSOCIATION
OF BROADCASTERS

STUDIOS & OFFICES:
104 1/2 W. WASHINGTON
JONESBORO, ARKANSAS

JAY P. BEARD, Owner-Manager
TELEPHONE 438

JONESBORO, ARKANSAS

January 23, 1939.

Mr. P. S. Gates,
Gates Radio & Supply Co.,
Quincy, Illinois.

Dear Mr. Gates,

If we have not already told you so, I want you to know that we are thoroughly pleased with the new Gates 20 B Console recently purchased from you.

We have had it in use for six days and the very first day it was in use we received many telephone calls from listeners complimenting our improved tone quality. We had made no announcement of installation of new equipment so we know they were sincere. We ourselves have noticed a considerable improvement.

To date we are using the same old pickups as previously used. The new pickups have been delayed in shipment. I am sure far better quality on transcriptions and records will be noticed when the new pickups are used. We have already noticed, however, better quality on records and transcriptions even with the old pickups.

Local lumber company built a walnut desk for this equipment to rest on and all in all we feel that our control room is as attractive as that of many stations of much greater power.

Please ship us at once complete set of tubes for use with our console and power unit. Send us the following tubes:

- 1 - 6F5
- 1 - 6J7
- 3 - 6C5
- 1 - 6F6
- 1 - 5Z3

We had no trouble in connecting the studio signal lights and it all is very neat and working very nicely. When you are down this way, be sure to come by.

Cordially yours,
Jay P. Beard
Manager, K B T M.

The New 100-D Control Console

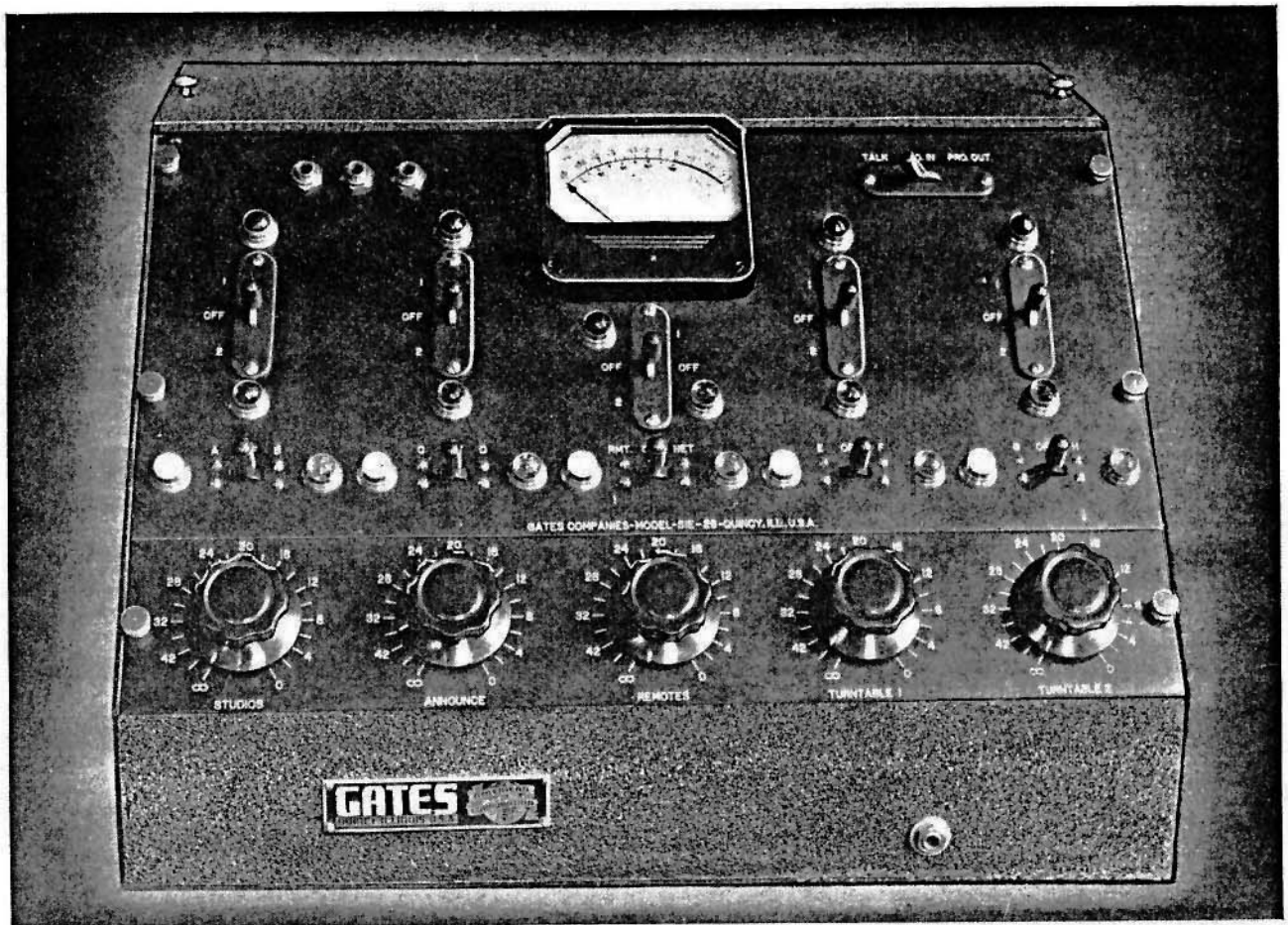

A new and complete control console with unlimited adaptability to any type of speech input system featuring:

- 1---T pad mixing control design.
- 2---Ten selective inputs to five mixing channels
- 3---Key selection any mixer to two amplifiers
- 4---Indicating lights for all circuits, 4 colors
- 5---Remote cue key
- 6---Removable mixing panel for cleaning
- 7---New 4 inch V. U. meter

The 100-D Console is not a complete speech system with amplifiers but for attachment to speech equipment where more elaborate control is needed. For console speech equipment see Gates Bulletin on 20 Series Speech Console.

full description next page

Grade A Line

GATES RADIO & SUPPLY CO. MANUFACTURING ENGINEERS QUINCY, ILL. U.S.A.

THE NEW MODEL 100-D CONTROL CONSOLE

DESCRIPTION

The "cry in the woods," as far as radio engineers are concerned, has always been for a control console that would have every possible combination of controls and circuits without too great a size or complicated design. In offering the new 100-D console it is not stated that it will do everything but go out and sign up new advertising contracts, but we do believe that it is the most complete control unit that has yet been offered by any manufacturer as a standard equipment.

In the first place the 100-D Console is not a complete speech input system, as it has no amplifiers. What it is, is actually a very elaborate mixing system so built that it may be placed on a desk, and control all circuits normally used in even the largest broadcasting station.

CIRCUIT DESIGN

It will be noticed that there are five horizontal keys and five vertical keys. The horizontal keys are input circuit keys with each key handling two input circuits to its respective mixing channel and having a center position as off. These keys also control loud speaker relays by the extra contacts provided and terminated at the terminal strip on the back of the console as well as operate the pilot lights adjoining the keys.

The vertical keys are amplifier selector keys, that is, each mixing position by means of these keys is selectable into a choice of two amplifier inputs, thus making it possible to operate any combination of mixing channels into one amplifier and setting up the remaining combination into the other amplifier for simultaneous auditioning, recording or broadcasting another program to a second station or net work.

MIXING CONTROLS

Of large size T pad design made by Daven and which sells net at \$17.50 each if bought individually. A truly grand smooth operating constant impedance control with negligible insertion loss that will last years and operate at long intervals without the need of cleaning. Without question the best mixing control on the market today. Five are provided and may be had in any common impedance used today such as 50, 200, 250 or 500 ohms. These are mounted on a 3¼x19 inch duraluminum panel which removes from the cabinet by two thumb screws on each end so that cleaning of controls is simplified to a few seconds' work.

KEYS

Of best grade obtainable with horizontal keys, a high quality anti-capacity switch to prevent any chance of cross talk between circuits and the vertical keys a 24 spring combination PBX type key to offer positive contact over years of constant operation.

CUE KEY

This is provided in the upper right corner offering three positions for handling the remote circuit over a single line. Position 1 offers a circuit for taking in the program for broadcasting, Position 2 a circuit for sending the preceding program over the line as a cue, and Position 3 for a direct order phone on the line.

JACKS

One is provided on the cabinet for head phones across the broadcast amplifier. Three extra of the PBX type are provided in the upper left corner for special or added circuits which may be used for either listening or direct patching.

OUTPUT METER

Incorporates the new large Model 30 Weston V. U. meter with scale B. Full 4 inch meter in two color scale design wired with recommended meter resistor in the circuit ready to connect to amplifier output or range switch. Recognized as the most accurate and desirable of all volume indicating devices.

PILOT LIGHTS

All front of panel type (lights remove from front) and equipped with 6 volt screw type 150 Ma. bulbs. Four different colors are used for each key position, namely red and green for the vertical keys and white and blue for the horizontal keys. Lights may operate from small six volt dry battery or any rectifier listed in the Gates catalog designed for 6 volt service.

TERMINATIONS

A screw type fully engraved terminal plate is located on the back of the cabinet for making all terminations.

CABINET

The cabinet is of heavy cold rolled steel resistance welded and finished in black baked ripple enamel. Panel is of duraluminum baked telephone black finish engraved in white. Panels are held to cabinet by simple thumb bolts making entire equipment quickly accessible for servicing when required. Cabinet overall is 19¼ inches wide, 12 inches high, and 15 inches deep. Panel size complete overall is 19x12¼ inches and panel slope is 45 degrees.

SUMMARY

In the 100-D Console is provided without patching of any kind the direct control of 10 input circuits into the choice of two amplifiers, control of speaker relays, remote cue circuit and order phone, volume indication of the latest type and illuminated indication of all circuits in use. Plus complete design and highest quality is provided an instrument of distinct appearance with the varied colors of indicating lamps and key handles of black and red producing an instrument of showmanship as well as efficiency.

Price

Model 100-D Control Console complete **\$275.00**

(Specify Mixer Impedance desired when ordering)
Code Word (YUJEV)

The 100-D Control Unit is standard equipment in the Gates 120-D dual cabinet speech system shown on other pages in the Gates catalog.

Linear Broadcast Amplification

in the
**10-D and 10-E
 HIGH GAIN AMPLIFIERS**

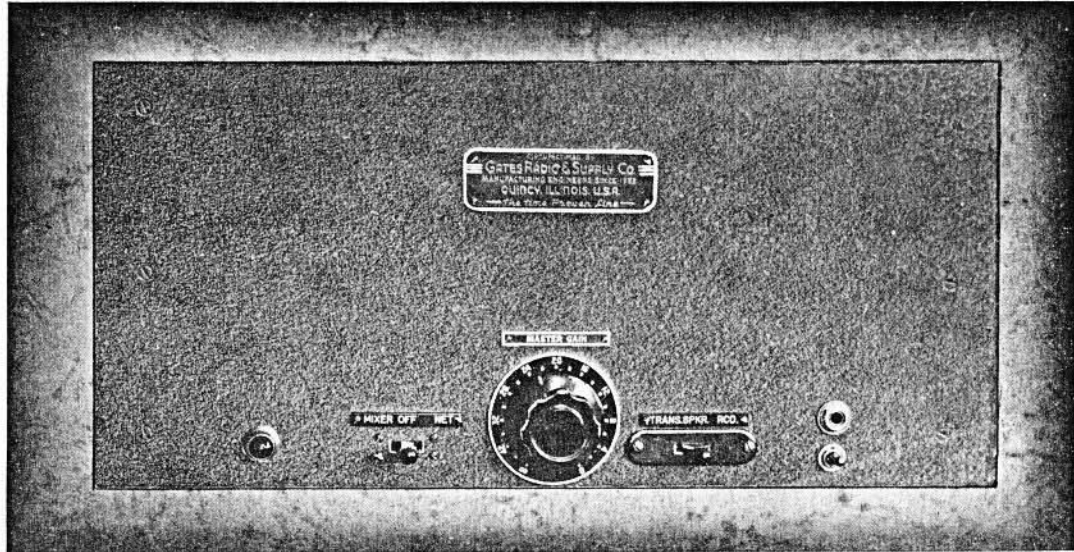

Five Top-Notch Features:

- 1---Three stage all push-pull circuit
- 2---Inverse feed back
- 3---Input key, selective 2 circuits
- 4---Output key, selective 3 circuits
- 5---Flat curve 30 to 15,000 cycles

Here is an all purpose amplifier that can be used as a studio, line or monitoring amplifier with the finest response and lowest noise characteristics known to the industry. We urgently recommend reading descriptive detail on the 10-D amplifier.

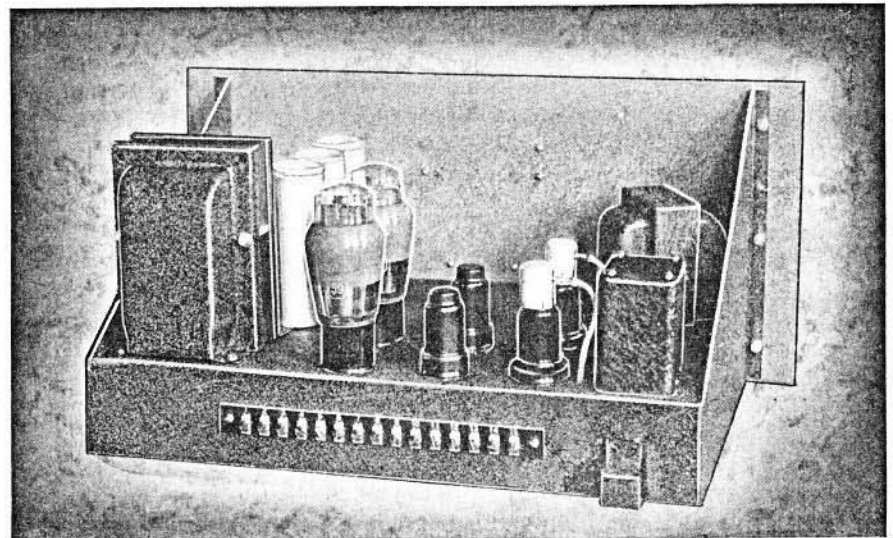

Grade A Line

GATES RADIO & SUPPLY CO. MANUFACTURING ENGINEERS QUINCY, ILL., U.S.A.

A New All-Purpose All-Frequency Amplifier for Radio Broadcasting and Recording

In this new amplifier is offered to the radio broadcasting station and recording industry a unit of unusual performance and unusual features at a remarkably moderate price. We are usually accustomed to seeing a line amplifier with so many tubes, a gain control and a switch to turn it off and on. In the Gates 10-D will be found, (1) a high quality high gain 3 stage amplifier with inverse feed back, (2) an input key allowing the amplifier input selective to two distinct circuits, (3) an output key allowing the output to be switched to any of the three circuits with one of these circuits padded for 0 Db. output, (4) push button tube plate current reading as optional, and (5) new approval vertical chassis construction giving more panel space and easier access to all parts.

GENERAL DESIGN

Built on standard panel $19 \times 8\frac{3}{4}$ inches and extending 10 inches behind the panel. Chassis made of resistance welded cold rolled steel in one piece, including side brackets which mount to the front panel by three screws on each side. Bottom cover removes easily for access to every part. Numbered terminal strip on rear provided for all terminations. Panel finish is available in a wide variety of colors, including black, steel gray, platinum gray, terra cotta and battleship gray. Though construction is principally for rack mounting, its size and design lends itself quickly to table or special console arrangements.

AMPLIFIER

Incorporates the much used all push pull circuit developed and featured by Gates during the past two years. Extremely low distortion and noise level is possible by the combination push pull, inverse feed back and four shield transformer construction. High gain of nearly 80 Db. adds to the desirability of this equipment. Three stages using two type 6J7 tubes in the first stage, two type 6C5's in the second stage, and two type 59 in the output stage provides a most efficient amplifier with a low tube cost. In this day of true high quality in broadcasting, low distortion content is demanded. A recent stock unit tested produced an actual distortion content of .25% without special selection of tubes and no special alterations whatsoever. These amplifiers are not released for shipment where the distortion exceeds .4% on test.

INPUT KEY

As this amplifier has been designed for versatility an input selector key is provided so that the amplifier may be selective of two input circuits as well as off. For example, the input key at one position may be connected to the mixer, while to the other position may be wired to the output of another amplifier, thus using it for recording, feeding a net work or auditioning. It is for this reason the input key has been labeled "Mixer" for one position and "Net" for the other. The input key is the left key on the front illustration.

OUTPUT KEY

In most modern speech cabinets will be found from two to five amplifiers such as the Model 10-D. In every case they are used for numerous purposes as well as spares. The output key allows direct switching of the output to three positions which have been labeled "Transmit" for use as a line amplifier for broadcasting, "Speaker" for use in feeding a loud speaker or speakers, and "Record" for use in feeding a recording head. The transmit position is series'd with a 10 Db. pad as level to the line for transmitting usually ranges from 0 to plus 5 Db.. Needless to say the markings given this key are merely for sake of labeling and any common requirement for the output may be handled by the output key. The point in having it in the circuit is that outputs from all amplifiers on the same circuit may be paralleled yet disconnected from each other by the fact that no two amplifiers will be operated at the same key position, yet in case of amplifier failure the second can be cut into the circuit instantly.

OTHER PROVISIONS AND SHIELDING

Controls are completed with the master gain control, head set jack, pilot light and starting toggle switch. Power supply is of full wave transformer type (no voltage doubler circuits used). All power supply equipment is properly shielded and phased for extreme low noise level. The input audio transformer has four complete shields as well as hum bucking design which results in a hum pick up so low that normal noises in battery operated amplifiers will show a higher reading on a noise meter than produced by this amplifier. Stock run equipments are producing noise level as low as 72 Db. below program level, which any engineer will agree is remarkable.

TECHNICAL DETAIL: INPUT IMPEDANCE—Selective at 50, 125, 200, 250, 333 or 500 ohms.
OUTPUT IMPEDANCE—500-600 ohms.
TUBES USED—Two each 6J7, 6C5 and 59, one 80.
GAIN—79 Db.
OUTPUT LEVEL—Maximum plus 22 at .4% distortion or less.
FREQUENCY RESPONSE—Flat within $\frac{1}{2}$ Db. from 30 to 15,000 Cps.
NOISE LEVEL—60 Db. or greater below program level.
LINE VOLTAGE—110 as standard but available for all voltages and frequencies.
WATTAGE—Consumes 117 watts at 110 volts 60 cycles.

Price

Model 10-D Amplifier—Complete with tubes ready to operate on 110 volt 50-60 cycle line **\$122.50**
Code Word (YUKOZ)

Model 10E Amplifier—Same as above only push button meter **\$137.50**
Tube Check, including meter
Code Word (YUMOC)

Add \$5.00 for Odd Voltage or Cycle

GATES RADIO & SUPPLY CO. MANUFACTURING ENGINEERS QUINCY, ILL., U.S.A.

New Model 106-C Program Amplifier

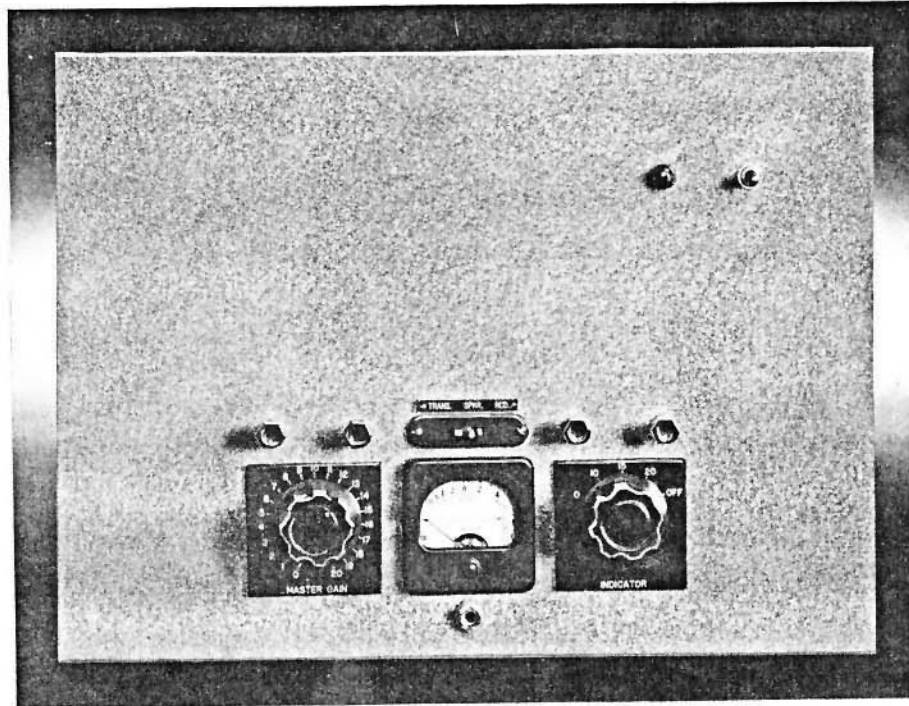

In the new and improved model 106-C amplifier will be found many features reflecting the modern and up-to-date broadcasting instrument requirements. It is complete and self contained, has no separate power supply, yet the noise level is guaranteed to be as low or lower than any similar equipment on the market today. Likewise it uses no voltage doubler type power supply but a full design full wave transformer type equipment not requiring isolation transformer or extreme care in grounding.

AMPLIFIER—Consists of 3 high gain stages developing 83 Db. gain by use of two 6J7 tubes in first stage, two 6C5 in second and two type 59 in third. A type 5Z3 rectifier is employed. Inverse feed back is part of the circuit producing distortion content of approximately .3% at plus 22 Db. output. Noise level is kept at 60 Db. below program level or greater by means of the special 3 shield transformer design, exclusive on all Gates A grade equipments. Frequency response is quite like drawing a line with a ruler, perfectly flat from 30 to 12,000 cycles not varying over 1 Db. at any point.

DESIGN—Panel is 10½x19 inches and may be had in ripple black, steel gray or terra cotta or in telephone black and plain steel gray. Vertical mounting of all parts on rear is provided by the shelf type chassis construction bolting to the front panel. Controls include master gain, meter range switch, push button plate current metering for all stages, output switching key and head set jack. Pilot light and starting switch part equipment. Meter may be choice of decibel meter having usual scale reading of -10 to plus 6 Db. or V. U. meter scale B Model 301. Decibel range switch has 5 positions of 0-10-15-20-Off. V. U. range switch has 6 positions of 0-5-10-15-20-25. State which type meter desired when ordering.

OUTPUT SWITCHING—A standard telephone key having three positions is provided and marked "Transmit", "Record" and "Speaker". At transmit position the output is padded 8 Db. before entering line. At record and speaker output is high level. This key allows use of the amplifier without changing of wires on varied output loads and is especially desirable where more than one amplifier is used as output circuits are paralleled yet never connected to the same common circuit.

POWER SUPPLY—Uses type 5Z3 tube in regular full wave design having impregnated power transformer, dual impregnated chokes and 600 volt oil filled filter condensers. For 110 volts 60 cycles or available for other voltages and frequency on special order.

TECHNICAL DETAIL

GAIN OVER-ALL—83 Db.
 NOISE LEVEL—From 60 to 70 Db. below program.
 RESPONSE—Flat from 30 to 12,000 Cps.
 INPUT IMPEDANCE—Universal 50, 125, 200, 250, 333 or 500.
 OUTPUT IMPEDANCE—500-600 ohms.
 MAXIMUM OUTPUT LEVEL—Plus 22 Db. at .3% distortion.
 DEPTH BEHIND PANEL—14 inches.

Price---Model 106-C Amplifier—Complete with Tubes **\$175.00**
 Code Word (YULUC)

Grade A Line

MODEL P-2 PRE-AMPLIFIER POWER SUPPLY

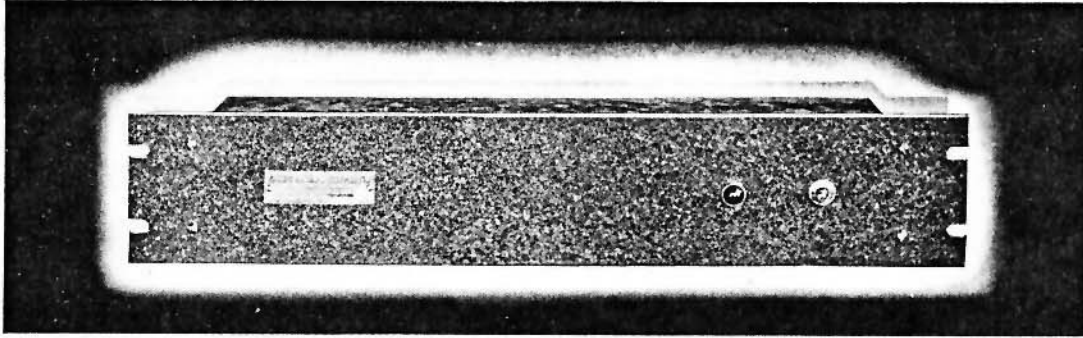

As a companion unit to our 56-B and 57-B pre-amplifiers the P-2 power supply takes its place to supply all filament and plate current for as many as 8 pre-amplifiers. It, of course, is by no means limited to Gates pre-amplifiers alone, as it, like all Gates apparatus, is built along standard engineering lines and quickly adapts itself to all standard-made equipment.

The P-2 power supply is built on a 19 in. by 3½ in. panel and is 5 inches deep behind the panel. Regular wide variety of finishes are available, such as black, steel gray and terra cotta ripple enamel, telephone black, and plain steel gray. Toggle starting switch and pilot light are only front panel items. Terminations are made to a numbered terminal strip on rear.

A full wave full design transformer type power supply is employed, using an excess of inductance and capacity for pure direct current to tube plates. A type 80 rectifier tube is used.

TECHNICAL DETAIL: FILAMENT CURRENT—5 Amperes at 6.3 Volts.
 PLATE CURRENT—40 Ma. at 250 Volts.
 LINE WATTAGE—45 at 110 Volts 60 Cycles.

Price—Model P-2 Power Supply—With Tube **\$24.75**
 Code Word (YUMAY)

LOW VOLTAGE RECTIFIER



In broadcasting stations and recording laboratories many occasions arise where a good low voltage direct current supply is needed such as for quiet relay operation, certain types of amplifier filament supply, etc.

In the A-5 rectifier illustrated will be found an equipment above the average for this general type of apparatus. Extra filtering by means of both large inductance and capacity plus a wide variety of voltages by means of primary adjustment makes the A-5 rectifier adaptable to a wide variety of purposes. It is built on a 5¼x19 inch panel and extension behind the panel is 6 inches. Terminations are to a numbered terminal strip. Pilot light and toggle switch comprise front panel equipment. On rear of chassis a rheostat is provided so that any voltage compensation can be made for increased or reduced load within plus or minus 40% of the rated voltage.

Model A-5—Delivers 6 Volts at 2.5 Amperes and Adjustable **\$45.00**
 from 3½ to 9 Volts. Continuous Operation
 Code Word (YULWA)

Model A-5A—Delivers 12 Volts at 2.5 Amperes and Adjustable **\$55.00**
 from 7.5 to 16 Volts. Continuous Operation
 Code Word (YULYE)

IMPROVED AGAIN

Today's Most Modern

PEAK LIMITING AMPLIFIER

featuring

"Compression Less Distortion"

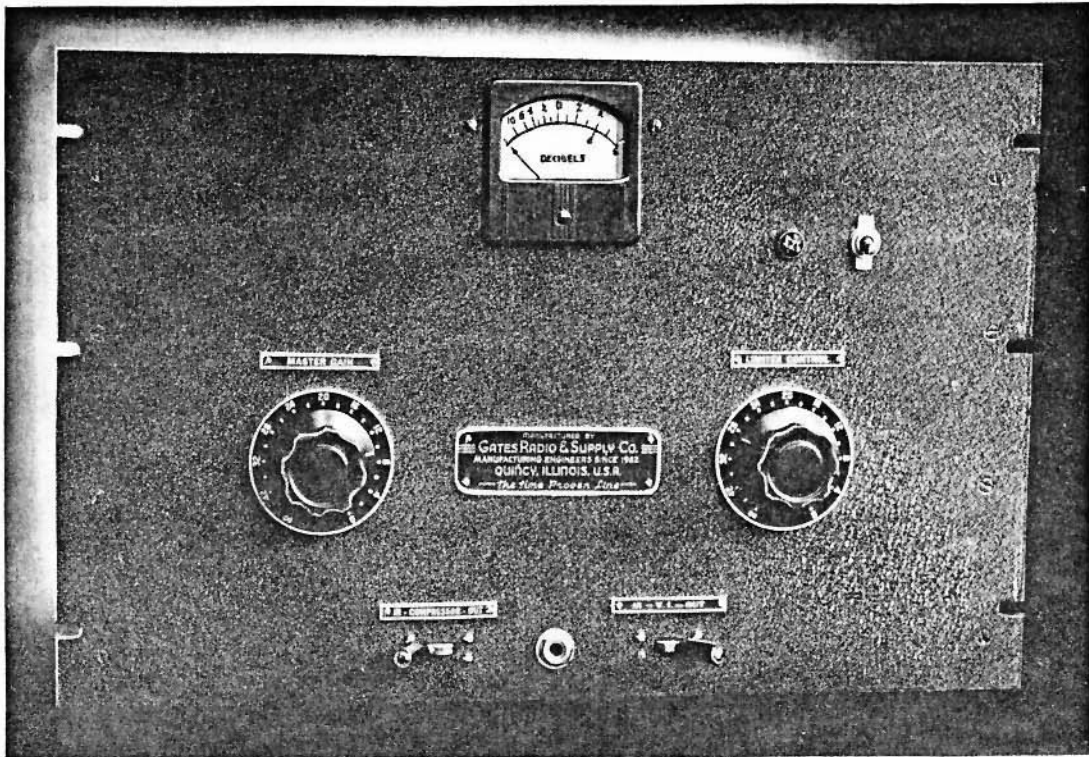

The 1940 Gates Limiter Offers:

- 1—Only $\frac{1}{2}$ of one per cent distortion at 4 Db. Compression.
- 2—Lightning fast effect time.
- 3—Inverse feed back.
- 4—Wide variety of models to choose from.
- 5—Guaranteed flat response, 25 to 15,000 CPS.

Manufactured by

GATES RADIO & SUPPLY CO. MANUFACTURING ENGINEERS QUINCY, ILL., U.S.A.

A New Gates Limiter in Your Station--What Will It Do?

Limiting amplifiers have been on the market now for about three years, in fact they were formally introduced at the N. A. B. Convention in 1937. Like any other new device, the first limiting amplifiers had something left to be desired, and in line with the Gates policy of improving as new developments arise, the new Gates broadcast limiting amplifiers are truly the finest and most modern equipments on the market today. Many improvements have been made which are discussed under individual heading, but the main question is: What will a Gates Peak Limiter do for me?

We believe the general engineering idea of the peak limiter is well known, so we will pass this by saying that audio peaks above a certain point are eliminated or automatically checked. The question then is: Why will a peak limiting amplifier increase my signal? Let's make a simple explanation. If in your car you had no top or cover on your gas tank, to keep the gas from spilling out when you hit a bump, you would fill it about

one-third full. That's simple logic. Now in broadcasting, if you want to keep from over modulating, which is an F. C. C. rule, you run the master gain control setting up about one-third that of full modulation to keep the quick peaks from splashing over and over-modulating. Now by adding a cover to your gas tank you can fill it to the top and hold about three times as much. By adding a peak limiter to your transmitting plant you, in the same sense of the word, place a cover on your transmitter; thus you can raise the gain setting, yet the quick peaks can not get out, but you still have a higher gain setting and much more broadcast volume on the air.

The peak limiter will, regardless of what may be thought to the contrary, not only increase your signal strength at least 3 Db. (which is equal to doubling power in every case) but do so with the new improved Gates peak limiter without increased distortion or any other evidence to the ear that limitation of peak signals is taking place.

Why the Gates New Improved Limiter Is Better

Limitation of peak signals is a simple matter, but the big question mark was limiting the signal above a certain amount without excessive distortion. Most limiting amplifiers were perfect until compression point was reached, then distortion, muffled sounds and the like took place, which was evident in the broadcast quality. Gates engineers set about to lick this, and that very thing they did by developing a dual compression or limiting system, a combination of the differential bridge and electronic system in an ingenious circuit that has brought acknowledgment from leading engineers of the superiority of this system. Briefly, the

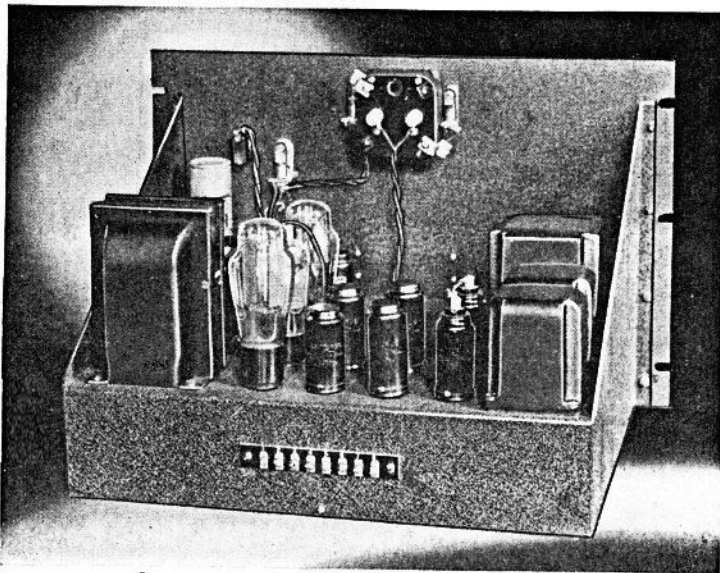

Rear View Construction Features

- 1—Vertical chassis design.
- 2—Transformer, hum bucking, cast cases, high permeability cores, static shields.
- 3—Balanced design throughout.
- 4—Resistance welded all steel chassis of heavy gauge.
- 5—Ease of servicing (removable base cover to reach all parts).
- 6—No extra power supply; all one unit and hum free.
- 7—First quality parts throughout.

OVER 100 EARLIER MODEL GATES LIMITING AMPLIFIERS ARE IN USE ASSURING GUARANTEED USER ACCEPTANCE.

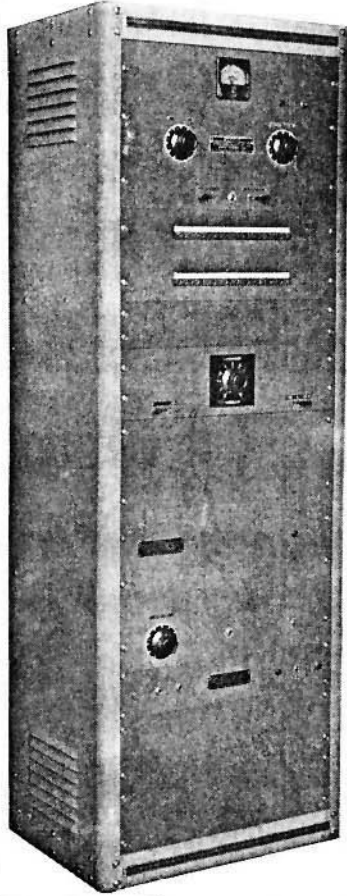

This is one of three Speech Racks at the new KVAN, Vancouver, Washington. Note 27-CO Limiter as top panel.

differential bridge is purely resistive and thus free from distortion, but it was sluggish, slow to act and slow to release, thus there was added to this a portion of the output rectified and so fed back into the circuit that the electronic system acted as the time control element and yet all of the good features of the differential bridge maintained. Result, immediate time for effect, just the proper release time and low distortion. Note this especially: distortion at 4 Db. of compression is .5% and at 15 Db. of compression 2%. No limiting amplifier can equal this performance as offered on the market today unless this same circuit is used.

Three Models Offered

Three models are offered. They are the same in their ability of peak limitation and differ only in output level. Model 27-C is a low level unit having three stages and an output of +6 Db. maximum. Its purpose is to attach to present line amplifiers. Model 27-CO is a complete self contained high level amplifier having a maximum output of +22 Db. The 27-CG is to feed a pair of class B 250 watt modulator grids direct without additional transformers.

Technical Design

All audio transformers used are linear standard manufactured for us by the world's largest transformer manufacturer. They are hum bucking design and have two additional shields not found on any stock transformer offered on the market. This accounts for regular run equipments having a noise level as low as 70 Db. below zero Db., also for the perfectly flat curve from 25 to 15,000 cycles. Oil filled filter condensers are used, power transformer and choke coil equipment are at least 25% larger than required, assuring cool operation. A full regulated type power supply is employed using a 5Z3 rectifier, 2A3 regulator, and 6C6 control tube. This assures perfect calibration of the compression curve under all line voltage conditions. Meter is of high speed type, rectifier design with rear scale illumination assuring no shadows. Controls are of best grade with main limiter control wiping contact design.

Push pull is employed throughout along with inverse feed back which in itself guarantees low distortion and noise level. Keys are provided so that the input may be passed through the limiting amplifier in case of tube failure, thus allowing tubes to be replaced without changing a wire or waiting until an off-the-air period. A key is also provided for switching the meter over to read input level to the limiter as well as compression level. The vertical type of rear chassis construction is employed, making possible much easier mounting, servicing and less panel space on the rack, 19x12 $\frac{1}{4}$ inch panel size, and 14 $\frac{1}{2}$ inches deep from front to back.

MODEL 27C has three stages using 6J7 tubes in first stage, 6F6 tubes in second, and 6C5 tubes in third. Output +6 Db. maximum. Input required not less than -25 Db. designed to attach to present amplifier equipment. Input and output 500 ohms.

MODEL 27-CO has four stages with maximum output of +22 Db. Uses two 6J7's, three 6C5's, four 6F6's, one 2A3, one 5Z3 and one 6C6. Designed as a complete self contained limiting type program amplifier. Input and output 500 ohms. Input level -25 Db.

MODEL 27GG has four stages using two 6J7's, two 6F6's, two 6N7's, two 6A5G's, one 6C5, one 2A3, one 5Z3 and one 6C6. This model is designed to drive two 838, 805 or similar tubes in class B, and is high level emitter. Input level -25 Db.

Technical Detail

It should be noted that in a limiting amplifier the rated over all gain is given as a limiting amplifier with compression action. For example, the gain of the Model 27-C is rated at 35 Db. as this is the rating at com-



Would you give less than 75c a day for one year to add many times the crowd shown above to your audience? A Gates Limiter will do it by increased coverage.

pression point. Actually, however, the amplifier will have 15 Db. more over-all gain than rated, but the first 15 Db. is not under compression, thus it is not mentioned.

GAIN OVER ALL—Model 27-C, 35 Db.
Model 27-CO, 47 Db.
Model 27-GG, 52 Db.

TUBES USED—See Model referred to under "Technical Design."

FREQUENCY RESPONSE—All models guaranteed flat within one decibel from 25 to 15,000 cycles.

DISTORTION CONTENT—At no compression .4%. At 4 Db. compression .5%. At 15 Db. compression 2%.

NOISE OR HUM LEVEL—Guaranteed 62 Db. below zero Db. or better.

IMPEDANCES—Models 27-C and 27-CO are 500 ohms in and out, but input is variable and may be changed to either 50 or 200 ohms. Model 27-GG is 500 ohms input and to push pull class B 250 watt grids. (Input class B transformer supplied but separate).

LINE VOLTAGE AND FREQUENCY—As standard equipment supplied for 110 volts 50-60 cycles. However, all commonly used odd voltages or frequencies may be had at only \$5.00 additional cost. Line wattage Model 27-C is 100, 27-CO is 135, and 27-GG is 150.

TIME FOR EFFECT—20 to 30 milliseconds.

TIME FOR RELEASE—300 milliseconds.

Prices

Model 27-C Limiting Amplifier —Complete with tubes and ready to operate	\$289.00
Code Word (YUFRE)	
Model 27-CO Limiting Amplifier —Complete with tubes and ready to operate	\$319.00
Code Word (YUFTO)	
Model 27-GG Limiting Amplifier —Complete with tubes and class B driver transformer ready to operate	\$325.00
Code Word (YUHTE)	

Gates manufactures a less expensive limiting amplifier for the communications industry to be used in airport, police, point to point and similar voice transmission. Your local police, airport or similar communications equipment user should be advised to investigate this.

Gates Is the Oldest Independent Broadcast Equipment Manufacturer

Established in 1922

GATES RADIO & SUPPLY CO. MANUFACTURING ENGINEERS QUINCY, ILL., U.S.A.

The Model 56-B No-Noise Pre-Amplifier

with

3 Extra Shields

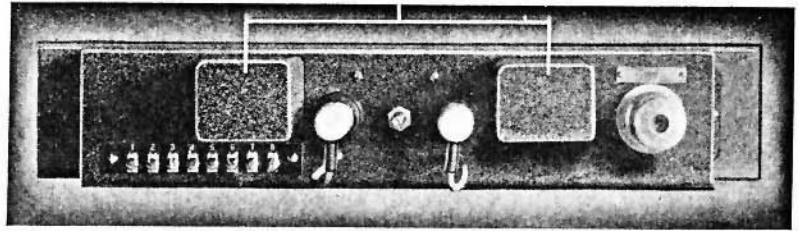

- a. Incorporates new hum proof and noise free transformers
- b. Two stage high gain circuit
- c. Universal in-out impedances
- d. A model for turn tables or microphones



Grade A Line

detail next page

GATES RADIO & SUPPLY CO. MANUFACTURING ENGINEERS QUINCY, ILL., U.S.A.

THE NEW MODEL 56-B PRE-AMPLIFIER

(with 2 extra shields)

In all audio circuits for either broadcasting or recording the pre-amplifier perhaps is the most sensitive of all amplifiers as to extraneous and internal noises. Always located in a low level circuit the slightest noise or the most minute hum content will be amplified to annoying proportions if existing.

In the new Gates 56-B pre-amplifier is incorporated a special design transformer patterned after rigid specifications of Gates engineers and briefly is a linear standard transformer surrounded by three separate alloy shields which along with extreme accurate hum bucking windings completely eliminates both electro-magnetic and static pick up from external sources. Tests made under operating tests with these special transformers brought noise content results as much as 81 Db. below program level where a power transformer of 150 watt size was located not over 10 inches from the input transformer of the amplifier. Similar tests were made with the best grade stock type linear standard transformers on the market carrying the regular catalog price of \$15.00 resulting in hum level averaging only 50 Db. below program level. It is because of this that we feel Gates engineers have made a marked advancement in low noise level high fidelity pre-amplifiers where alternating current is used for filament supply and rectified current for plate supply.

CONSTRUCTION

Standard panel size of 3½x19 inches is employed with rear chassis 16 inches long, 3¼ inches wide and 2 inches deep held to the panel by two thumb bolts instantly removable for servicing. Panel finish may be had in black, steel gray or terra cotta ripple enamel or telephone black or plain steel gray. Input connects through 8 contact plugs which may accommodate a microphone direct or be used for correct impedance termination by mere choice of proper terminal numbers on plug. Power connections and output is made to the 8 contact terminal strips shown on the rear illustration. Front panel equipment includes choice of jacks or push buttons for plate current measurement of each tube, pilot light and filament switch.

AMPLIFIER

Has two stage using special noise tested 6J7 tubes as triodes. Overall gain is 49 Db. A model is available with volume adjusting control on the rear chassis where the amplifier is used for turn table service while the standard model is without control for use as a microphone amplifier.

TECHNICAL DETAILS

INPUT IMPEDANCE—Variable 50, 125, 200, 250, 333 or 500 ohms.
OUTPUT IMPEDANCE—Variable 50, 125, 200, 250, 333 or 500 ohms
(both input and output wired 200 ohms when shipped)
DISTORTION CONTENT—0.3%.
NOISE LEVEL—60 Db. or greater below normal output level.
FILAMENT DRAIN—.75 amperes at 6.3 volts.
PLATE DRAIN—.4 Ma. at 250 volts.
FREQUENCY RESPONSE—Flat within 1 Db. from 30 to 15,000 Cps.

Prices

Model 56-B—Complete with tubes and ready to operate **\$44.50**
Code Word (YUMEZ)

Model 57-B—Same as above only balancing volume
control added for turn table operation **\$45.50**
Code Word (YUMIB)

Model 9K Volume Indicator

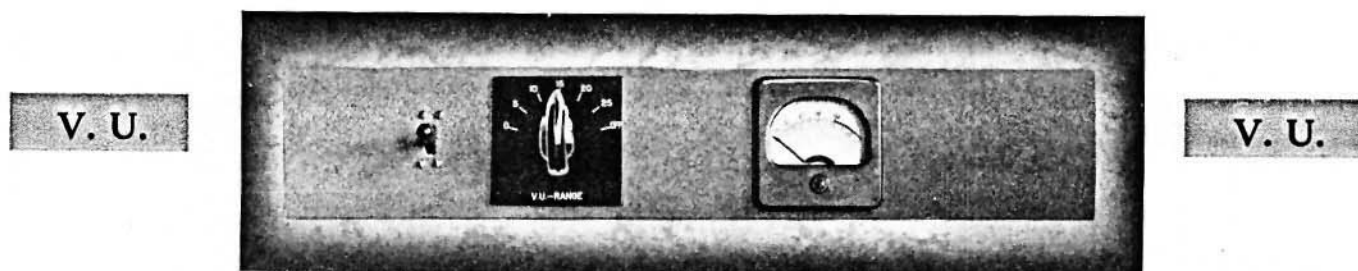

In the past few months the V.U. meter has come into a great deal of popularity, some of which is rightfully deserved, and Gates offers in the new Model 9k volume indicator panel a neat commercial unit in a variety of styles to suit the requirements of all broadcasting stations. The variety is not in the actual equipment supplied so much as it is in the type of range switch and meter scale required by the particular installation, and it is because of this that various models different than the standard model are available.

The standard model uses a Weston Model 301 rectangular case V.U. meter having scale B or that scale with the numerical listing on the top of the scale such as 0 to 100 and the V.U. listing directly under the numerical listing. This scale is most widely used. A six position range switch is provided giving six V. U. steps of 0-5-10-15-20-25. Range switch is a special design L pad made to Gates specifications by Daven. A key is provided on this panel which is used for making the V. U. meter instantly available for measuring two amplifier circuits instead of one by simply throwing from one circuit to the other by means of the key, or one side of the key may be connected to the program amplifier output with the other side terminated at the patch panel for measuring any circuit desired.

DESIGN

Panel size is $3\frac{1}{2} \times 19$ inches and like all Gates equipment may be had in any commonly used color such as ripple black, steel gray, or terra cotta or telephone black or plain steel gray. Dust cover is provided to protect rear equipment, and an 8 contact terminal strip accommodates all connections.

The advantages of the V.U. meter need not be mentioned in detail on this page as they are well known, most important being extreme accuracy, almost instant up-swing and retarded back-swing giving a meter easy to follow, combined with lack of overshoot and inaccuracy that oftentimes prevails with other types of meters.

SPECIAL TYPES

Three models are available to meet broadcast requirements besides the standard model listed above. All models consist of the same essential material, namely, key, range switch and meter and vary as to design.

TYPE 10K and 10KK

Has a range switch reading from 0 to 40 V. U. in steps of 0-15-20-25-30-40 and is for amplifiers operating at a higher level than 25 V. U. which is maximum for the standard model and yet has no added cost. Model 10K has meter scale B and 10KK meter scale A.

MODEL 11K and 11KK

Same as above model only has 8 position range switch reading 0-5-10-15-20-25-30-35 V. U. Model 11K has meter scale B and 11KK scale A.

MODEL 12K and 12KK

Same as above only reads to 50 V. U. in 5 V. U. steps of 0-5-10-15-20-25-30-35-40-45-50. For use with high wattage amplifiers or laboratory service. Model 12K has meter scale B and 11KK meter scale A.

Prices

Model 9K	---Standard Model, Scale B	Code Word (YUJOY)	\$54.00
Model 9KK	---Standard Model, Scale A	Code Word (YUJTA)	\$54.00
Model 10K	---As described	Code Word (YUJUZ)	\$60.00
Model 10KK	---As described	Code Word (YUJVE)	\$72.00
Model 11K	---As described	Code Word (YUJYO)	\$72.00
Model 11KK	---As described	Code Word (YUKAV)	\$54.00
Model 12K	---As described	Code Word (YUKCY)	\$54.00
Model 12KK	---As described	Code Word (YUKIX)	\$60.00

Grade A Line

Patch Panels

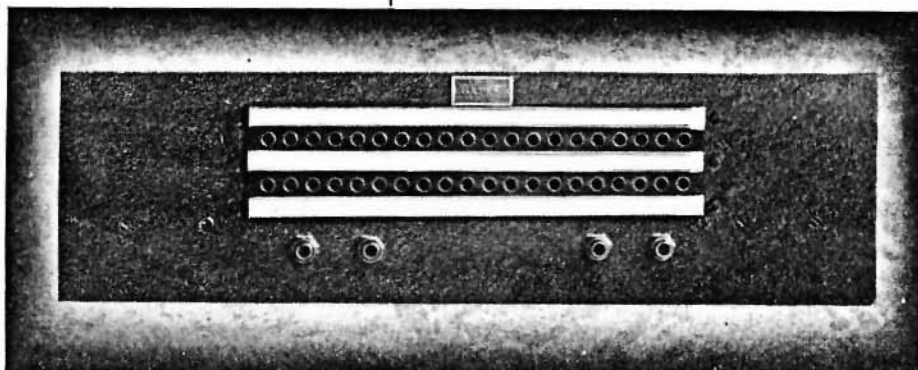

In the rack type speech system the patch panel is an almost indispensable piece of equipment, as of course it is this equipment that binds by means of either patch cords or interlock the various circuits of the entire speech equipment and likewise terminates the outside circuits such as remote lines, microphones, etc. In these new Gates patch panels is provided what is perhaps the finest jack obtainable today manufactured for Gates by Stromberg-Carlson and having behind it the actual telephone board proven test of millions of patches without wearing of contacts or spring tension. Several types are offered differing in the type and quantity of jacks supplied. All jacks are mounted 20 to a strip over which is a standard No. 2 designation strip supplied blank and on which may be penned or typed the jack heading.

Two types of jacks are available. No. 130 is the open circuit type or having two circuits, and the third circuit (shell) grounded. Jack No. 135 is a closed circuit jack used in interlock as well as open circuits so that when the patch cord is not used the jack locks up to the circuit automatically. The shell circuit is ground and is the fifth connection for the No. 135 jack. Like every Gates item all types of finishes are available such as ripple black, steel gray and terra cotta, and telephone black and plain steel gray.

Patch cables are not supplied with panels and are listed separately and may be purchased in the number required. Standard cable uses an 18 inch shielded green telephone cable with Stromberg-Carlson No. 53X plugs on each end. Longer patch cords may be had at slight additional cost.

- | | |
|---|----------------------|
| Type A-130 —This type has 20 No. 130 jacks and indicator strip on 3½x19" panel | Price \$34.00 |
| Code Word (YUKUB) | |
| Type A-1300 —This type has 40 No. 130 jacks with indicator strip over each bank of 20 jacks | Price \$54.00 |
| Code Word (YUKVA) | |
| Type A-1301 —This type has 60 No. 130 jacks with indicator strips over each bank of 20 jacks and on 5¼x19" panel | Price \$74.00 |
| Code Word (YUKWE) | |
| Type B-140 —Same as type A-130 only No. 135 closed circuit jack used | Price \$39.00 |
| Code Word (YUKZO) | |
| Type B-1400 —Same as type A-1300 only No. 135 closed circuit jack used | Price \$64.00 |
| Code Word (YULBO) | |
| Type B-1401 —Same as type A-1301 only No. 135 jack used | Price \$89.00 |
| Code Word (YULIZ) | |
| Patch Cables —As above described complete | Each \$5.00 |
| Code Word (YULOB) | |

Grade A Line

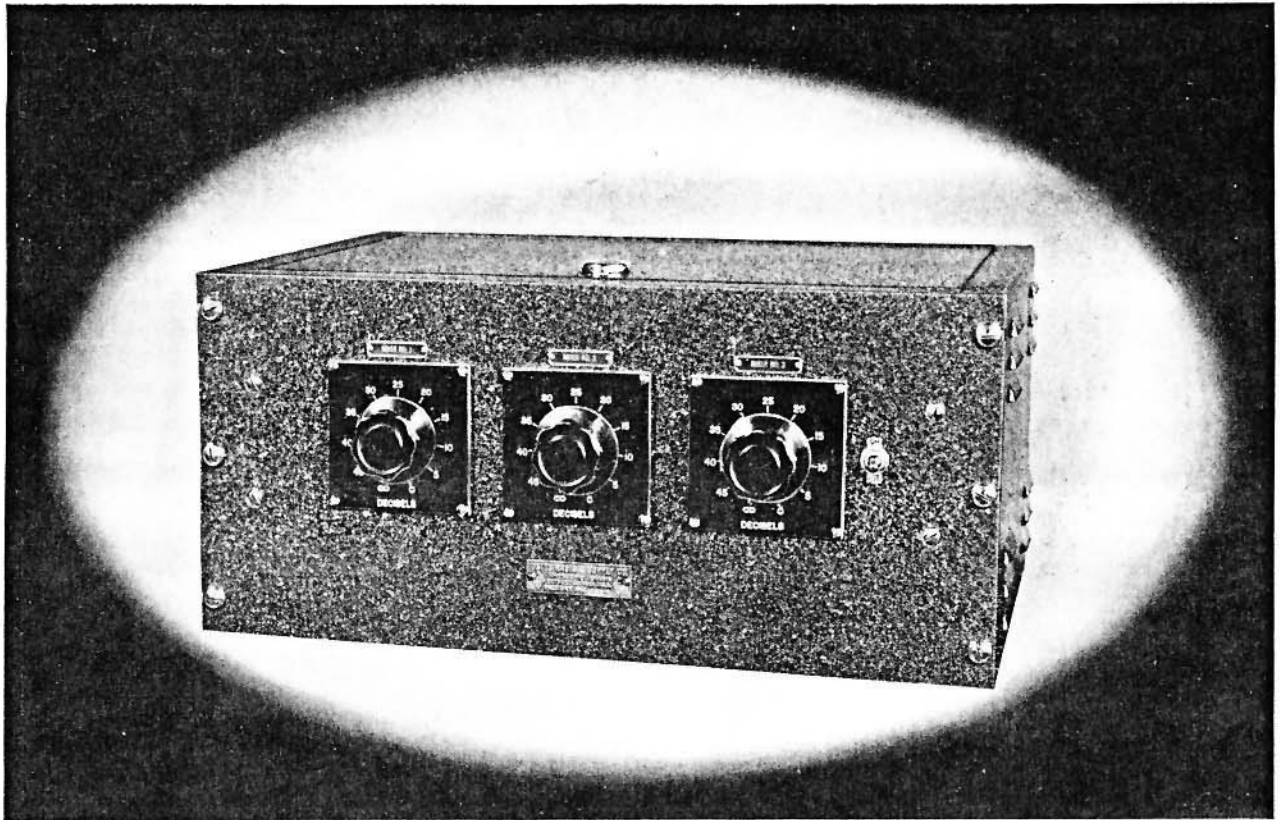

“The Trio-Pre”

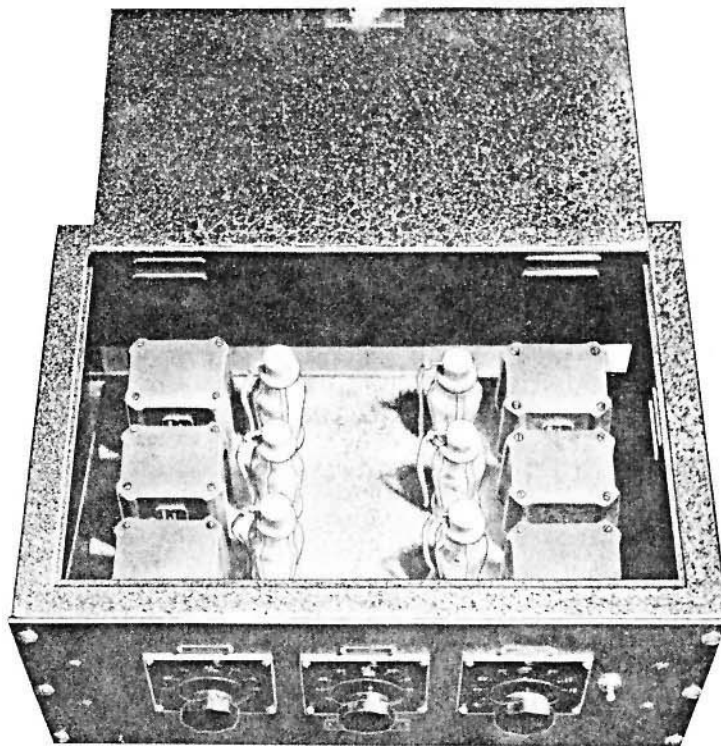

This is a popular item in the Gates line for many months. It is actually three Model 56-B two stage pre-amplifiers on one panel $8\frac{3}{4} \times 19$ " and extending 14" behind the panel with a potentiometer type mixing control in each pre-amplifier. The output of each amplifier is tied together common so that only one input is required to the high level amplifier. Its major purpose is to supply a need where both additional mixing and pre-amplification is required and a minimum of rack space is demanded or offering an equipment for desk control where used in the cabinet model as illustrated.

A complete detail as to each amplifier can be obtained by referring to bulletin A1004 on the 56B pre-amplifier as each of the 3 pre-amplifiers in the trio-pre are identical to the 56-B having added the mixing control for each pre-amplifier. Input connection by plugs and any impedance may be had from 30 to 500 ohms. Output is also likewise variable. Power may be obtained from P-2 power supply listed bul. A1002 or equal. Model B is for rack mounting while Model C is supplied in handsome desk cabinet finished in black $8\frac{3}{4}$ " high, 15" deep, 19" wide with hinged lid. Amplifier uses optional of 6C6 or 6J7 tubes.

Model B _____ **\$140.00**

Code Word (YUMUD)

Model C _____ **\$148.00**

Code Word (YUMYA)



Guardian of the Air Lanes

In the making of radio transmitting equipment it of course cannot be said that with each instrument some life depended upon its performance. However it is not infrequent when Gates supplies equipment where human lives in a measure depend on its ability to produce unfailingly under a wide variety of conditions. In the above illustration is the main control tower at the Chicago Municipal Airport, world's largest, where nearly a million lives are brought in and sent on their way via air each year. Gates audio equipment including their latest contribution to broadcasting, the improved limiting amplifier, is used every hour of every day at this world's busiest dispatching point for air transportation.

Is it not only fair to say that such important uses of Gates equipment indicates confidence in its design, performance and construction in the greatest degree possible? In all probability if any instrument you might purchase from Gates would fail no life would change even one heart beat, but it is indeed gratifying to know that the equipment you are purchasing is built just as if some life depended upon its continual unfailing service day in and day out.

Gates Equipment Is Made That Way

GATES RADIO & SUPPLY CO. MANUFACTURING ENGINEERS QUINCY, ILL., U.S.A.

MODEL 50-A MONITOR AMPLIFIER

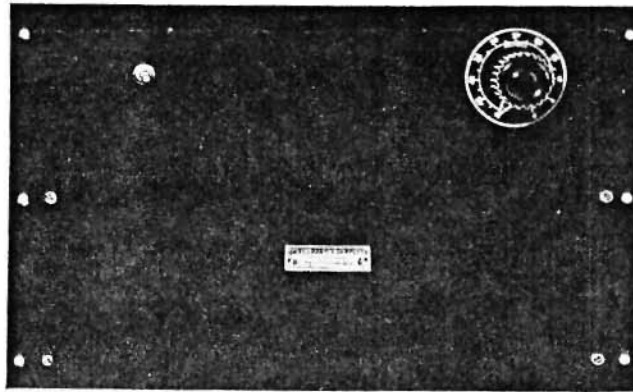

In the broadcasting station in many cases the monitoring amplifier need not be as elaborate as the program or line amplifier yet of course equally fine in fidelity and performance. The Model 50-A is a moderate priced rack type amplifier with all fundamentals existing, yet having the so-called ginger bread eliminated to keep the price at a moderate level for an item of this type. Built on a vertical rear chassis quite similar to all Gates products and having a front panel of 10½x19 inches it uses three stages, the last of which is push pull. Master gain control, pilot light and starting toggle switch only panel equipment.

AMPLIFIER—Has 3 stages using 6J7 first stage, 6N7 second stage, and push pull 2A3 in last stage. Uses 5Z3 rectifier and full transformer type power supply with oil filled filter condenser 600 volt size. Model 50-A has input of 50, 125, 200, 250, 333 or 500 ohms, while Model 50-B has bridging input of 16,000 ohms. Both models have output of 500 ohms.

TECHNICAL: GAIN—70 Db.
 RESPONSE—Flat from 40 to 12,000 cycles.
 NOISE—50 Db. below program level.
 OUTPUT—12 watts at 4% distortion, 6 watts at 1% distortion.

Model 50-A or 50-B Amplifiers—With Tubes **\$79.00**
 Code Word (YUMCO)

Grade A Line

MODEL 10-C LINE EQUALIZER



The 10-C equalizer is designed for strict telephone line equalization or where low frequencies become boomy and high frequencies either thin, lacking or distorted. Equalizes at low frequencies based on line capacity reducing high frequency response. Has maximum equalization of 48 Db. or capable of excellent equalization of a 24 mile line and quite satisfactory equalization of much longer lines.

Panel is 5¼x19 inches, having rear dust cover protecting all parts. Input key provided to cut equalizer in and out of circuit which parallels line to be equalized. A two position key on right side of panel allows two equalizing settings, thus giving a greater dial range for varied steps of equalization.

Model 10-C Line Equalizer—Complete **\$49.00**
 Code Word (YUCUS)

Grade A Line

A Word About Broadcast Speech Material

As we all know, audio equipment can be built cheaply or well. Obviously a cheap amplifier can sell for much less than a well built one, but like any other product whether or not it be broadcast equipment, top quality cannot be improved upon by merely adding to the price. In Gates made speech units absolute top quality is employed and the prices as stated all cover equipment that cannot be bought in any better form either in parts quality or workmanship. If Gates prices are lower than competition it is simply because they, as always before, have been willing to accept a reasonable rather than an exorbitant profit. We realize that there are still a few in the broadcast industry that believe they only obtain the best by paying the highest price. Fortunately these individuals are fewer each year, in fact more than ever before Gates has in its list of clientele many names of international importance and prominence. Corporations that could easily afford the highest priced prefer Gates as they have realized that into each Gates item, no matter how small, goes the most possible in research and quality.

It can therefore be said that the Gates line is so priced that it can be afforded by those companies with the most restricted budgets yet preferred by Corporations that weigh their equipment dollar, buying equipment on merit alone and not on high price or name prejudice.

Research of course like the word guarantee is much overworked. Those that have purchased Gates equipment can hardly deny that research has been the foundation of the equipment. Those that have purchased some Gates item that require exercising of the guarantee rights likewise cannot do other than say that Gates has been quick to replace or adjust the defect and that interpretation of the guarantee was broad and open-minded.

The Gates organization was founded by the late Henry C. Gates in 1922. Started from scratch, so to speak, it has grown to an organization of international note in the affairs of radio transmitting. In the government classification of small business (roughly 500 employees or less) Gates is definitely a small business. Our customers know this is only to their advantage as, like the large university with thousands of students, individual personal attention in large amounts in student-professor relations is no more possible than in a large business is individual customer-company relations. Gates is proud of the fact that each customer can be given every co-operation in problems, suggestions and attention. Our customers cannot take too much of our time and they cannot exasperate us with unlimited questions, no matter how simple they may seem to us. We likewise realize that we are not above making a mistake, but realizing that our number of customers are restricted to the relatively small number of broadcasting stations in the world, we strive to prevent mistakes and hasten to remedy the error if it prevails.

Our terms are net cash or C.O.D. if credit has not been established. All equipment is F.O.B. Quincy, Ill. Export terms are strictly net cash in advance plus estimated transportation and insurance costs where purchaser is located in a warring country. Neutral countries may send 50% with order and the balance will be sent C.O.D. except in those countries that allow equipment to be delivered to the consignee by the purchase of a bond and in this case full cash in advance is demanded.

REMOTE
EQUIPMENT
CATALOG

The DYNAMOTE

For One solid year
America's leading
Remote Equipment

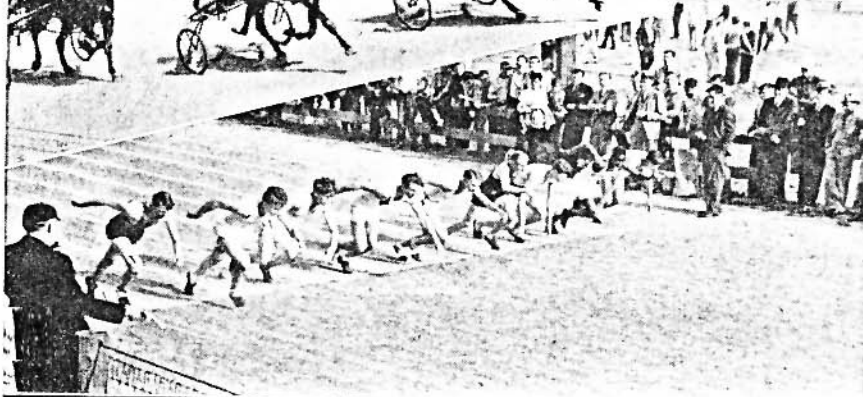
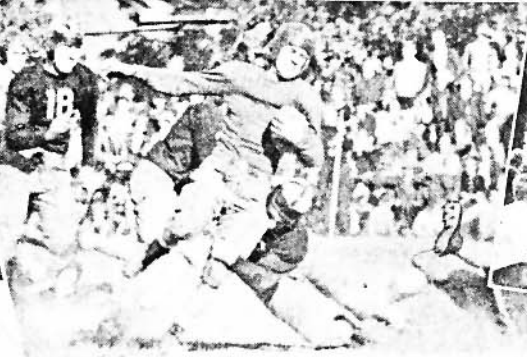
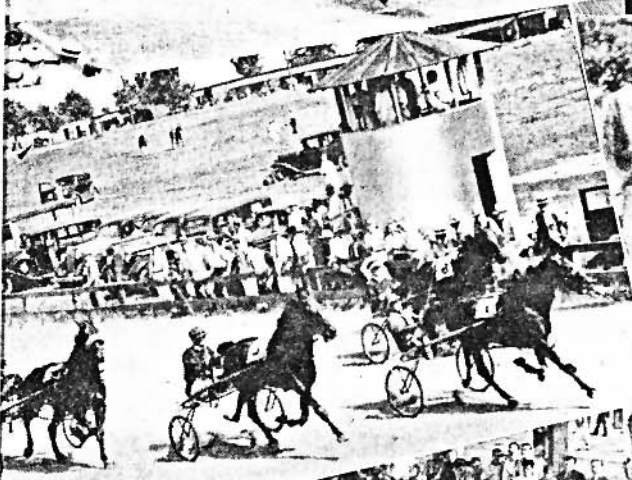
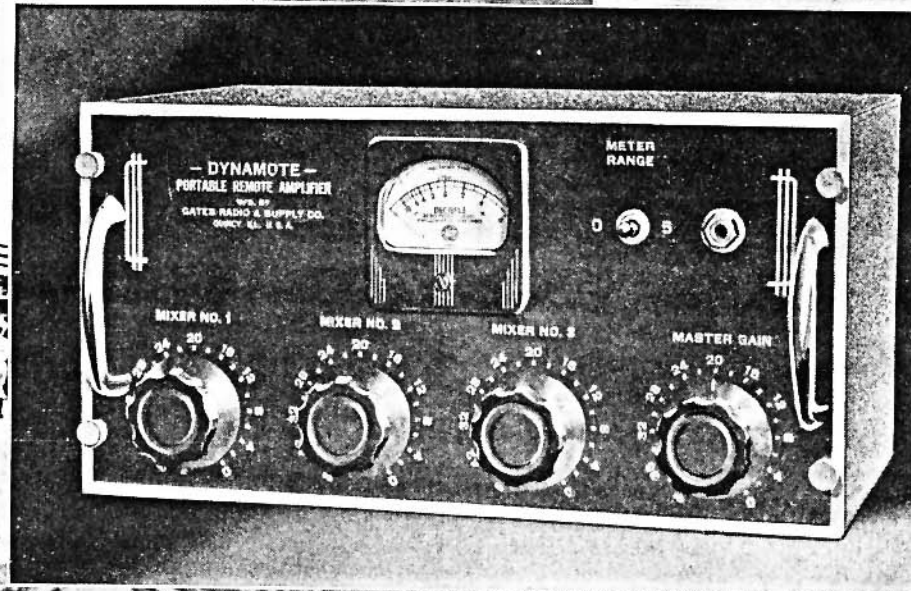

GATES RADIO & SUPPLY CO. MANUFACTURING ENGINEERS QUINCY, ILL., U.S.A.

THE NEW GATES DYNAMOTE

Dynamote

Users

KVAN

WTIC

WFBM

WTOC

KZIB

WFDF

WHJB

WSOY

WJMS

CKTB

WCHS

WGN

WHBQ

WLOK

WGY

WJRD

WNOE

KRE

WSUI

WJLS

WAIM

KFXJ

WDSM

WGBR

WLNH

KLUF

WGRC

KALB

CKOC

WKZO

CFQC

WABY

KOME

CKCK

KFVD

KRIC

KFWB

House
of
Representatives
Washington,
D. C.

The New Gates Dynamote is offered to the discriminating radio broadcasting station with the feeling that nothing finer is available in remote equipment regardless of price. So certain are we of this that all other remote equipment in our catalog selling at a higher price than the Dynamote has been discontinued. In the Dynamote the broadcaster is offered superb appearance in modern streamlining, perfect audio frequency response, the use of only the finest parts and a completed unit that will stand beside the best competing equipment and ask no apologies and yet be many dollars less in price.

How the Dynamote is Built

The Dynamote is in two units which slip into a sturdy leatherette covered carrying case and carried as one. The carrying case has a false bottom which has sufficient room to carry three average size microphones, headphones and other incidentals. Hardware is well plated to prevent rusting and carrying case is lined with heavy green felt to prevent marring the equipment. The Dynamote amplifier cabinet is 14 1/4" long, 7" high and 8" deep. It houses the four stage high gain amplifier, mixer, V. I. meter and all parts. Note in the rear view how microphone connectors, telephone line and power cable terminate.

The power supply unit is complete for operation off of the 110 volt, 60 cycle light line (odd voltage or cycle available on special order). It is 7x4x8 inches in size and connects to the amplifier cabinet with a 3 foot joiner cable supplied. Batteries, of course, may be used where light current is not available.

The front panel of the Dynamote employs the new etched on aluminum process that defies wear or unsightly appearance after years of service. All dial letters and other engraving stand out in natural aluminum with the base color of the panel being in semi-dull gloss black polished smooth. This panel is definitely not an engraved panel but a genuine etched finish which will not wear with age.

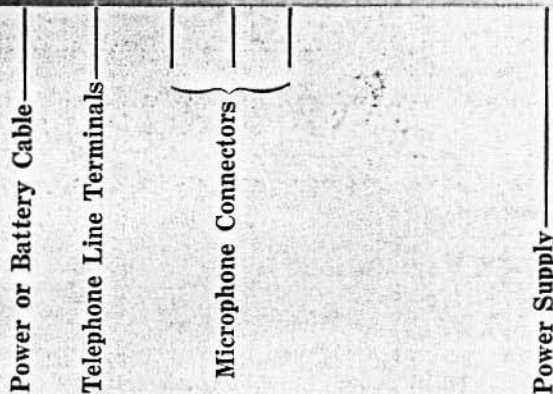
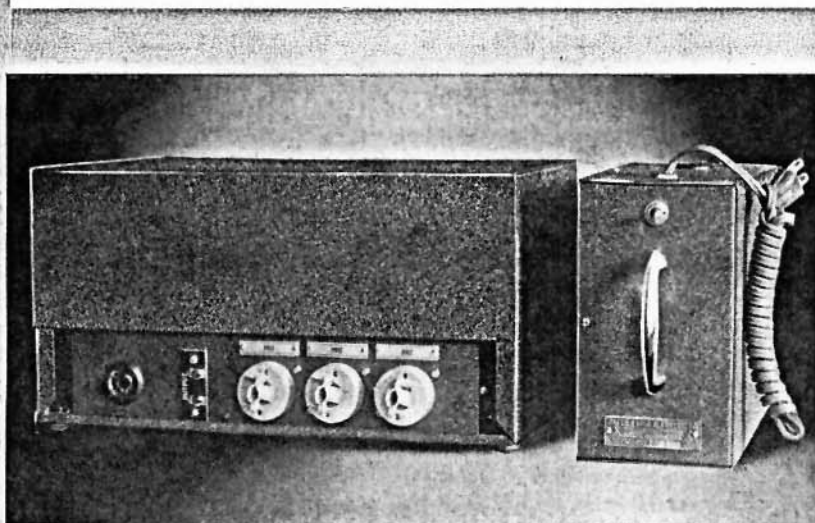

DYNAMOTE REAR ILLUSTRATION

--- In Beauty

--- In Performance

--- In Light Weight

--- In Rugged Design

--- In Response

--- In Price

The
"DYNAMOTE"
Leads

TECHNICAL DESCRIPTION

Each part of the Dynamote equipment is discussed technically under headings so that quick reference can be made though it, of course, should be understood that the equipment is supplied altogether as one complete equipment.

Mixer ---

Three positions are provided allowing mixing for three microphones. Controls are genuine Daven wiping contact with low insertion loss and operating noise level below -130 Db. Mixer is available for either 200-250 ohm microphones or 30-50 ohm microphones. Microphones connect to standard equipment through heavy Hubbell twist lock connectors. Full size skirt knobs provided allow easy gripping for positive operation.

Amplifier ---

The amplifier has four stages all operating as triodes and using a type 6J7, two 6C5 and one type 6F6 tubes. Amplifier has unusually high gain and hum level when used with the power supply is guaranteed 60 Db. below program. Frequency response is guaranteed flat within one decibel from 30 to 12,000 cycles. Distortion content at plus 8 Db. output is .7% or less. Output terminates at the telephone line terminal strip on the back of the cabinet (see rear illustration) and also to a head set jack provided and to the volume level meter. The master gain control like the mixer controls is of the wiping contact type with low operating noise level and with detents.

Volume Level Indicator ---

This is a standard high speed decibel meter with meter range switch provided so that the meter may read actual scale which is from -10 to +6 Db. or may be padded 5 Db. and thus read 5 decibels above scale. Meter is of the square case type fully illuminated from the rear through a transparent scale and is of the high speed action design having well built cobalt magnet to assure quickness of action and lasting capabilities.

Price

\$174.50

Complete

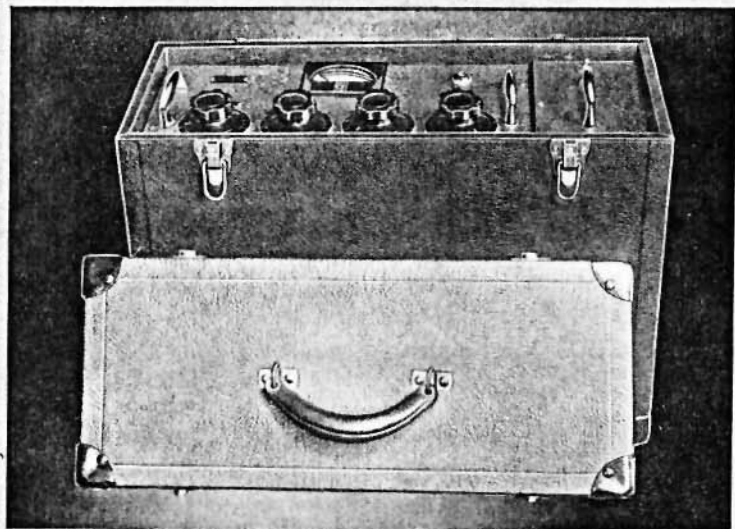

For small size, light weight, ease and speed in packing and unpacking and yet room left for three microphones and other accessories in the case, the only answer is the

“DYNAMOTE”

Power Supply ---

Th employs a slow heating type 84 rectifier tube in a standard full wave circuit (voltage doubler circuits are not employed in Gates built equipments). Power supply is well filtered and has ample reserve current supply to prevent any semblance of heating over long schedules. Power supply connects to amplifier through joiner cable supplied with plugs on each end. A. C. connection is through cord also provided. Starting switch is part equipment.

TECHNICAL SPECIFICATIONS

Tubes used—1 each 6J7, 6F6, 84, two type 6C5.

Frequency response—Flat within one decibel from 30 to 12,000 cycles.

Distortion content—Seven tenths of one percent measured at plus 8 Db.*

Over all gain—From input of mixer to line terminals, 91 Db.

Hum level—With power supply connected 60 Db. below program.

Input impedance—Available for either 30-50 or 200-250 ohm microphones and should be specified when ordering.

Output impedance—500 ohms.

Maximum capable output—Plus 12 Db. at 1% distortion content or less.*

Line watts for A. C. operation—35 at 110 volts, 60 cycles.

• •

Where batteries are used in place of power supply the following information is given:

Plate drain—22 Ma. at 180 volts.

Plate voltage recommended—180 volts.

Filament voltage—6.

Filament drain—1.5 amperes with meter light unscrewed.

Overall gain—With 180 volts in place of power supply, 86 Db.

• •

Weight packed and complete—37 lbs.

Size packed—19¼" long, 8" wide, 12" high.

• •

The Dynamote is recommended for all types of remote or sub studio broadcasts and may be used with all types of prevailing low level microphones now in use today.

*As measured on General Radio distortion and noise measuring equipment.

PRICE: Dynamote complete with power supply, tubes and carrying case..... **\$174.50**
Code Word (YUHET)

Same as above only with V. U. Meter..... **\$192.50**
Code Word (YUIRG)

Be sure to specify whether for 30 or 200-250 ohms.

For odd voltage or cycle add \$5.00. 25 cycle equipment carried in stock.

If battery case desired add \$9.75.

If Cannon P-3 connectors required in place of Hubbell, supplied as standard, add \$26.00.

The Remote Conditioner

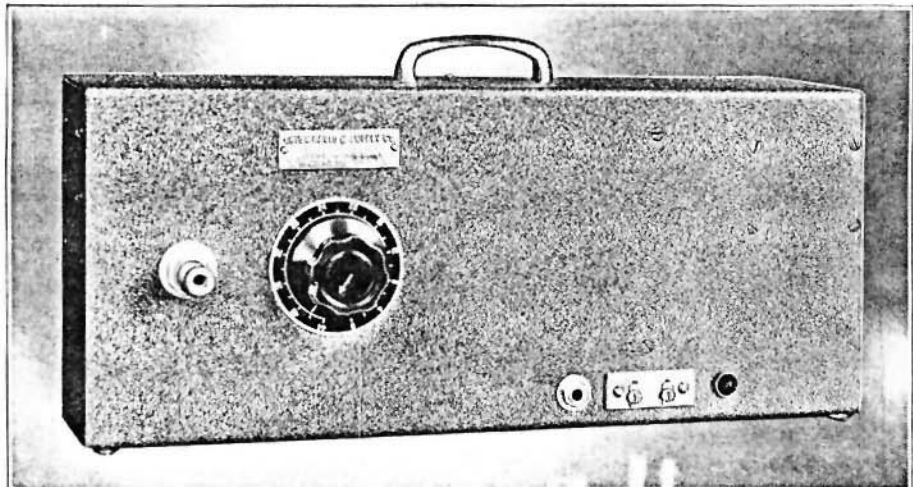

.... A complete A. C. operated Remote Amplifier for low level microphones all self-contained and without a trace of hum.

Recondition Your Remotes with the "Remote Conditioner" \$62.50

Nearly 1000 in Use Today

Description

The "Remote Conditioner" is unique because few A. C. operated remote control amplifiers have been successfully built having the power supply, high gain amplifier and input transformer all in the same small case without any trace of hum. The success of this equipment is best illustrated by its long list of users.

The "Conditioner" was originally designed as a unit to take the place of the large number of older battery type and outdated remote equipments that had a high maintenance cost or poor response or insufficient gain for use with modern microphones. However, seemingly more broadcasting stations used the "Remote Conditioner" for new remote additions, as its quality, size, low cost and simple design was attractive for single microphone pick ups.

Three stages are used having an over all gain of 89 Db. The power supply is self contained and of full design transformer type (not doubler design) using an 84 slow heating rectifier tube. Hum is eliminated by careful engineering, placement of parts and the use of hum bucking coil design in audio transformers. Hum level is guaranteed 55 Db. below program level. The Conditioner is equipped with master gain control, pilot light, starting toggle switch, head set jack, screw type output terminal strip and locking type microphone connector. Back cover of cabinet is removable to reach tubes and majority of parts without further dismounting.

The "Remote Conditioner" is made in two models, the 6L for 30 ohm input for use with dynamic microphones and the 6R having universal input of 50, 200, 250 or 500 ohms and for use with velocity or inductor microphones. Size 17 in. long, 7 in. high and 4 in. deep. Provided with chrome handle for portability.

TECHNICAL DETAIL: TUBES USED—One each 6F5, 6C5, 6F6, 84.
GAIN—89 Db.
HUM LEVEL—55 Db. below program level with microphone of —60 Db.
LINE WATTS—50 at 110 volts 60 cycles.
INPUT IMPEDANCE—6L, 30 ohms; 6R, variable, 50 to 500 ohms.
OUTPUT IMPEDANCE—500 ohms.
FREQUENCY RESPONSE—Flat within 2 Db. from 45 to 10,000 cycles.
DISTORTION CONTENT—Not over .5% at plus 10 Db., less at lower levels.

NOTE—Those desiring to use 30 ohm microphone should purchase Model 6L even though Model 6R has 50 ohm input provisions as only 250 and 500 ohm windings on Model 6R are balanced.

Price---Model 6L Remote Conditioner —For 30 ohms input.....	\$62.50
Code Word (YOZHE)	
Model 6R Remote Conditioner —For Universal input.....	\$62.50
Code Word (YOZIJ)	
Model 6H Remote Conditioner —High impedant input.....	\$64.50
Code Word (YUHIU)	

Note: Add \$5.00 for odd voltage or cycle.

The "Receiving-Remote" Amplifier

A
Complete Remote
with a
Small Radio Tuner
Part Equipment

Take cue via radio....
Flip a key and radio is
off and remote is on
the air.

**Saves on order
wires**

Eliminates complicated
monitoring systems.

Prevents mistakes

Cue can not be missed.
No Head Phones needed.

Here is an old idea in a
new compact dress that
is amazingly simple, fool
proof and positive in re-
sults. Priced to fit your
budget.



The "Receiving-Remote"

Here is an equipment that some engineers will no doubt wonder as to its need with present day cueing systems using order wires or feeding back the program over the same line for cues to the remote. However, after inspecting the simplicity of the operation and the fact that these complicated methods are not needed with the "Receiving-Remote," its application in broadcasting pick up work will immediately be recognized as not only practical but desirable. Though the "Receiving-Remote" is recommended for all remote control service where a single microphone can be used, it is especially desirable for emergency pick ups where other cueing methods can not be easily set up.

The amplifier, power supply and input arrangement are the same as in the Remote Conditioner described on the preceding page. For technical detail on this part refer to the detail on the Remote Conditioner. The radio tuner is a simple one R.F. untuned stage and a detector which feeds into the audio section of the remote amplifier and then into a small self-contained 5 in. loud speaker. Tuning to station frequency is by means of a slotted control on the front panel adjusted by a screw driver and then always left to broadcast frequency. A separate volume control is provided for the radio. Before the remote broadcast, key shown in center lower position, is turned to position "Radio" which connects the tuner through to the speaker. As soon as cue is received the key is depressed to position "Amplifier" and radio is shorted out and disconnected, and remote amplifier is connected to the telephone line. Speaker cuts off in the same operation to prevent feed back.

A short wire of 3 or 4 feet is required for antenna, or antenna may be one side of the telephone line. Though tuner is simple it will give excellent reception in the 2 to 3 Millivolt area which is sufficient.

Size 20 in. wide, 7 in. high and 5 in. deep. For gain, hum level, distortion content and frequency response of remote amplifier see description on Remote Conditioner (preceding page). Line watts at 110 volts 60 cycles, 55.

TUBES USED—One each 6F5, 6C5, 6F6, 6K7, 6J7, 84.

Model 9A—For 50, 200, 250 or 500 ohms, 110 v., 60 c. **\$89.00**
Code Word (YUASF)

Model 9B—For 30 ohms input and 110 volts, 60 cycles **\$89.00**
Code Word (YUAUG)

Model 9C—For high impedance input, crystal mic., etc. **\$84.00**
Code Word (YUBAM)

For odd line voltage or cycle add \$5.00

The "Remote Compact"

A complete reduced size remote equipment for A. C. or Battery operation and where a single microphone is sufficient. Available with or without V. I. meter. V. U. meter also available.

4-Star Highs ★★★★★

- ★ High fidelity.
- ★ High gain.
- ★ High quality.
- ★ High commercial appearance.

4-Star Lows ★★★★★

- ★ Low hum level.
- ★ Low distortion.
- ★ Low maintenance cost.
- ★ Low purchase cost.

The "Remote Compact"

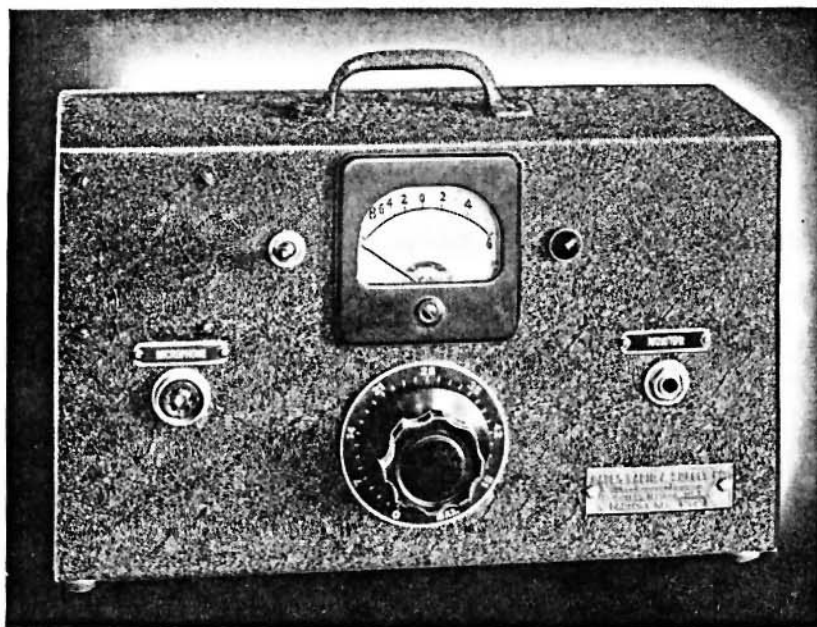

GR-80 Compact with V. I. Meter Equipped

★★★★★

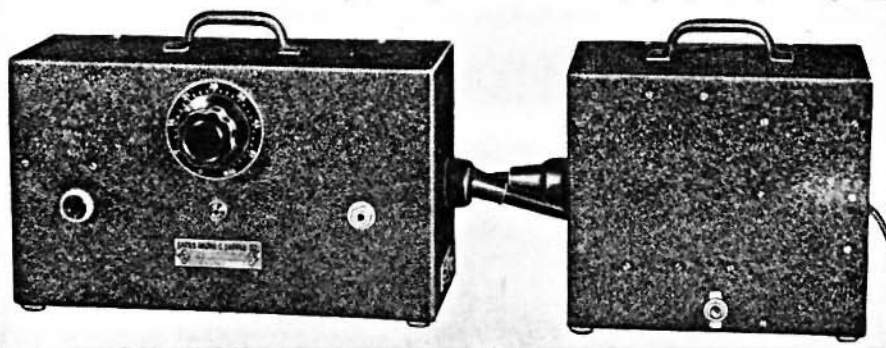

GR-70 Standard Compact

Power Supply

★★★★★



Packed

DESCRIPTION "REMOTE COMPACT"

The "Remote Compact" is another of those time proven Gates built remote equipments that has seen many months of service in many of the country's leading broadcasting station. As circuit and component improvements came along they have been embodied in the "Remote Compact" until today it is without question the ace remote equipment for single microphone operation. It is, as the name implies, very small in size and light in weight. When packed in the carrying case it is no larger than a small hand satchel, yet in this same case there is room for the microphone of any type and a pair of head phones. The "Remote Compact" is made in two types, the GR-70 standard without volume indicator meter and the GR-80 with volume indicator meter.

Model GR-70

The amplifier unit is separate from the power supply to keep hum level to the lowest point ever attained in A. C. operation. It has three high gain stages, allowing an easy +10 Db. output if desired when used with any Velocity or Dynamic microphone. Type 6F5, 6C5 and 6F6 tubes are used in the metal type tube. Master gain, locking type microphone connector, pilot light, head set jack and screw type output terminal strip all part equipment. Size of amplifier: 12 inches long, 7 inches high, and 4 inches deep.

Model GR-80

This is the same fundamental equipment as the GR-70 only having as added equipment a fast action square case decibel meter with scale reading from -10 to +6 Db. An additional padding switch is provided allowing a 10 Db. loss in the meter reading, thus giving an actual meter check from -10 to +16 Db. All other equipment as mentioned under Model GR-70 prevails in this model. Model GR-80 is also available with V. U. meter, Weston Model 301 Scale B.

Power Supply

This is identical for both models and is supplied with either as part equipment. Is of transformer type (not voltage doubler) with full size filter and having as its only control the starting toggle switch. Connects to amplifier through connecting cable supplied. Size 7x7x4 inches. Tube used, Type 84. Features plug in type filter condenser.

General Features

The input to the amplifier is variable and may be changed at will for use with 30-50, 200-250 or 500 ohm microphones by means of a multiple terminal connection on the input transformer. All transformers have high permeability cores, low distributed loss and balanced windings. Output is 500 ohms but may be had at 200 or 50 ohms at no additional cost. The extreme low hum level in this equipment is brought about by careful engineering, use of balanced windings and heavy cast cases on all audio transformers, selected hum free tubes and oversize filter in the power supply. This equipment is guaranteed unrestricted to be free from all hum regardless of frequency or conditions.

TECHNICAL DETAIL: TUBES USED—One each 6F5, 6C5, 6F6, 84.
 GAIN OVER ALL—85 Db.
 HUM LEVEL—55 Db. Below Program.
 DISTORTION CONTENT—.5% at plus 10 Db. less at lower levels.
 INPUT IMPEDANCE—Variable.
 OUTPUT IMPEDANCE—500 ohms.
 LINE WATTS—50 at 110 volts 60 cycles.
 FILAMENT DRAIN FOR BATTERIES—1.2 amps. pilot light disconnected.
 PLATE DRAIN—22 Ma. at 180 volts; 17 Ma. at 135 volts.
 BIAS—Internal

Prices---Model GR-70—Complete with Power Supply and Case **\$79.50**
 Code Word (YUBMA)
Model GR-80—Complete with Power Supply and Case **\$97.75**
 Code Word (YUBNE)
Model GR-80V—Same as GR-80 only with V. U. Meter **\$115.75**
 Code Word (YUJAT)

Either model above, less carrying case, deduct \$7.00
 For odd voltage or cycle add to above prices \$5.00

GATES CATALOG

B-23
of
ACCESSORIES

for the
RADIO BROADCASTING
STATION

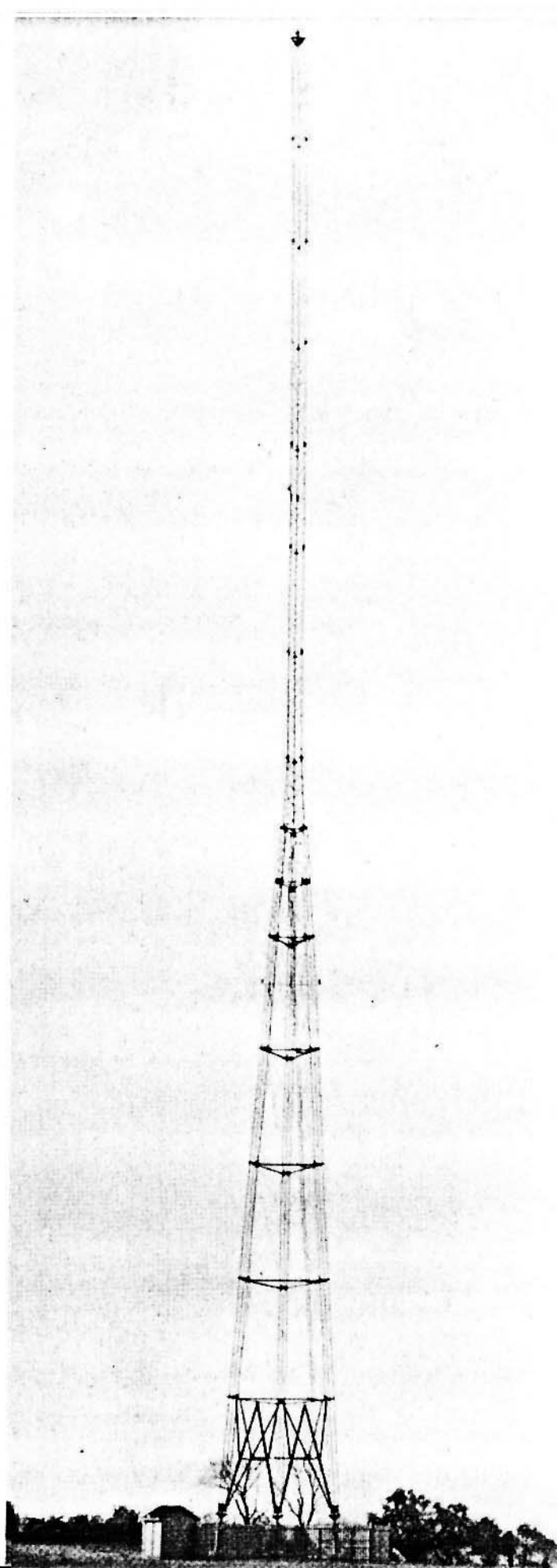

GATES RADIO & SUPPLY CO. MANUFACTURING ENGINEERS QUINCY, ILL., U.S.A.

2 TYPE "A" TRANSMITTER RACKS

★★ SLATE GREY RIPPLE FINISH

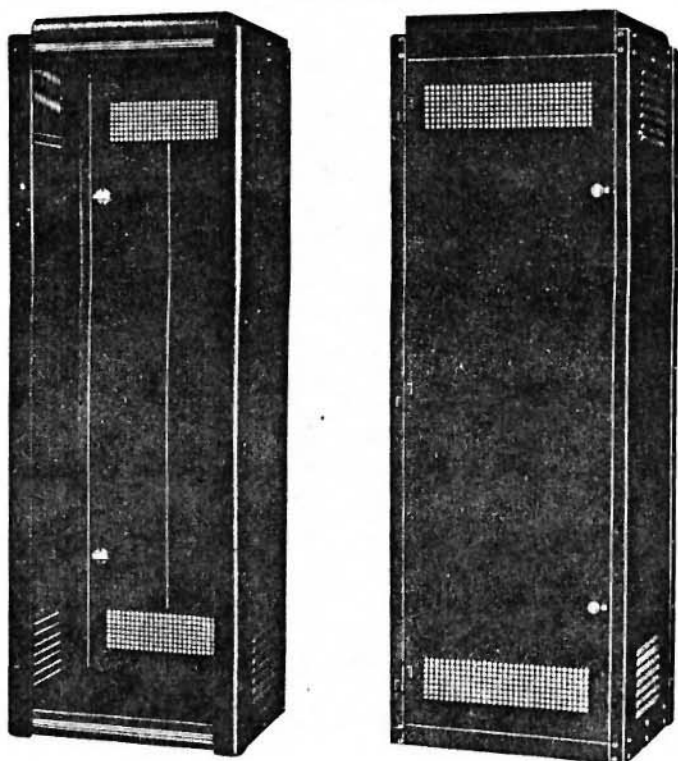

Produced in the new "streamlined" style, this rack is fully in keeping with modern design. The removable vertical corner mouldings are rounded and cover the panel mounting screws, the same as is used on our Type "C" commercial racks. The top, which has also been "streamlined", is perforated at the back to provide additional ventilation. The top and bottom are trimmed with red striped chrome finished mouldings.

This rack is substantially fabricated from 1/16" cold rolled steel; the panel mounting angles are of 1/8" steel, accurately drilled on universal centers for either type "A" or type "C" panels, tapped for 10/32 machine screws. Panels fit into a recess, so that the edges are not exposed. Louvers in the sides and screen sections in the rear door provide ample ventilation. The rear door is hung on sturdy loose-joint hinges, and closed by two flush snap catches. The racks are shipped "knocked-down" with all necessary bolts for easy assembly.

★★ BLACK RIPPLE FINISH IS OPTIONAL IF SO SPECIFIED ON YOUR ORDER.

METER PANELS

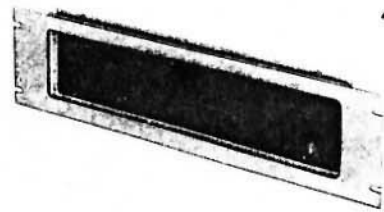

These panels are made so that the meters may be recessed from the front of the panel. Meters are protected by a plate glass insert, allowing 3/4" clearance in back of panel. A blank bakelite sub-panel is provided. The clear sub-panel space is 4 1/8" x 15" on the 19" wide panel which is sufficient for 4 - 3" meters. On the 24" wide panel the clear sub-panel space is 5 3/4" x 20".

Cat. No.	Cat. No.	Size	List Price
P-690	G-690	5 1/4" x 19"	\$ 6.00
P-691	G-691	7" x 24"	10.50

SOLID DOOR PANELS

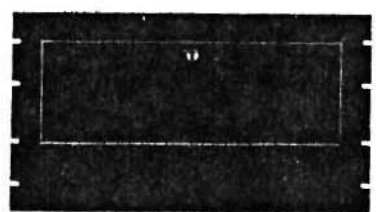

These panels have flush hinged doors with full length piano hinges; they are equipped with a chrome knob and concealed snap catch. All doors are located 1" from top to allow space for chassis at bottom. Regular chassis brackets may be used if desired.

Cat. No.	Cat. No.	Panel Size	Door Size	List Price
P-670	G-670	8 3/4"	4 1/2" x 15 3/8"	\$3.60
P-671	G-671	10 1/2"	6" x 15 3/8"	4.00
P-672	G-672	12 1/4"	7 1/2" x 15 3/8"	4.60

BLACK RIPPLE FINISH — BLANK



TYPE ER-213---OVERALL DIMENSIONS: 42 BY 22 BY 16 1/2"
 AVAILABLE PANEL SPACE 36 1/2" BY 19"
 CLEAR INSIDE WIDTH (FRONT) 17 5/8"
 CLEAR INSIDE WIDTH (REAR) 19"
 CLEAR INSIDE DEPTH 15 1/2"
 PRICE COMPLETE \$27.00 SHIPPING WT. 100 LBS.

TYPE ER-215---OVERALL DIMENSIONS: 66 1/2 BY 22 BY 16 1/2"
 AVAILABLE PANEL SPACE 61 1/4 BY 19"
 OTHER DIMENSIONS SAME AS ER-213
 PRICE COMPLETE \$36.00 SHIPPING WT. 150 LBS.

TYPE ER-217---OVERALL DIMENSIONS 82 1/2 BY 22 BY 16 1/2"
 AVAILABLE PANEL SPACE 77 BY 19"
 OTHER DIMENSIONS SAME AS ER-213
 PRICE COMPLETE \$42.00 SHIPPING WT. 175 LBS.

Width	Shpg. Wt.	List Price	Width	Shpg. Wt.	List Price
1 3/4"	1	\$1.50	12 1/4"	4	\$5.75
3 1/2"	1	2.10	14"	4	6.50
5 1/4"	2	2.65	15 3/4"	5	7.25
7"	2	3.15	17 1/2"	5	7.75
8 3/4"	3	3.80	19 1/4"	6	8.75
10 1/2"	3	4.85	21"	7	10.25

SPEAKER PANELS

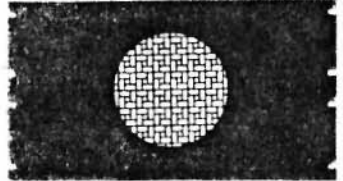

Panel Size	Hole Size	Speaker Size	Shpg. Wt.	List Price
8 3/4" x 19"	4 1/2"	6"	6 lbs.	\$2.25
10 1/2" x 19"	6 1/2"	8"	8 lbs.	2.70
12 1/4" x 19"	8 1/2"	10"	9 lbs.	3.50
14" x 19"	10"	12"	10 lbs.	3.90

CONNECTORS



TWIST LOCK CHASSIS CONNECTOR
 Flush type twist lock heavy 10 amp. contacts. Base diameter 1 1/2" Depth 1 5/32". 3 way polarized. Price--No. 430 connector----.95



MALE TWIST LOCK
 Popular twist lock connector with cable clamp. Shell reinforced composition. 3 way polarized for use with 430 or 441 connectors. Price--No. 440 connector---\$1.20



MALE CHASSIS CONNECTOR
 Same as No. 430 only male contacts inside and female No.441 connector used. For remotes where protruding contacts not desired. 3 way polarized. Price--No. 431 connector----.95



FEMALE TWIST LOCK
 Quite like No. 440 only female type. Has clamp for cable, twist to lock and heavy 10 amp. contacts. Used with 431 or 440 connectors. Price--No. 441 connector---\$1.50



CHASSIS CONNECTOR
 Standard 3 way 10 amp. polarized non twist lock. Top and base separate for mounting. 1 1/2" deep. 1 9/32" diameter. A well built plug. Price--No. 432 connector----.85



MALE CONNECTOR
 3 way 10 ampere non twist lock but polarized. Used with 432, 990 or 991 female connectors. Has clamp for cable. Price--No. 442 connector---\$1.45



Heavy Duty Locking Plug
 This is a de luxe 8 contact plug of the fully shielded locking type. Finished in cadmium with firm gripping pins. Without question the finest multi contact plug at a moderate price available today. Type 08M Plug---\$1.25



Microphone Plug
 This is a small yet heavy duty 3 conductor plug fully shielded and of the locking type. Used for low or high impedance microphones. Nickle finish. MC3M Mic. Plug----75c

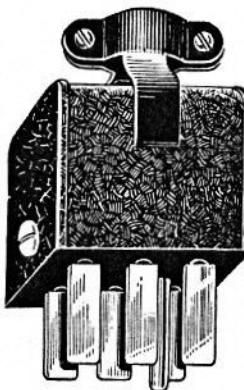

Heavy Duty Plugs

This plug is available from 2 to 12 contacts. Moulded spade contacts into bakelite make this an outstanding plug for power or audio cables. Metal cover with clamps for cable is provided. Thousands of these have been sold by us to broadcasters everywhere.

- 2 Contact----\$.85
- 4 Contact----1.05
- 6 Contact----1.25
- 8 Contact----1.50
- 10 Contact----1.70
- 12 Contact----1.95



Extension Locking Socket
 Used with the 08M plug for extension cables of all types. Fully shielded, cadmium plated and 8 contacts. Excellent for power or audio cables. Type 08F Ext. Socket----\$1.25



Extension Plug and Socket
 Has same plug as MC3M and equipped with extension socket for use in breaking up microphone cables. Locking type, 3 contacts and nickle finish. MC3 Extension Plug and Socket--\$1.50

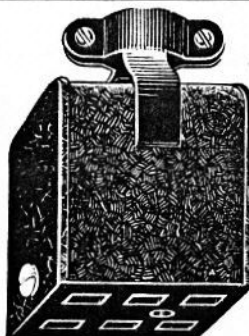

Heavy Duty Extension Sockets

The mate to the plugs listed above. Used for all power or audio cables for heavy duty work. Has cap and clamp for cable.

- 2 Contact----\$1.50
- 4 Contact----1.60
- 6 Contact----1.70
- 8 Contact----1.80
- 10 Contact----1.85
- 12 Contact----1.95

Heavy Duty Chassis Connector



Used with the 08M plug for connecting into steel chassis up to 3-16 inches thick. Cadmium plated and plug may be locked to socket. Has 8 contacts. Type P08F Chassis Con. ----80c



Chassis Connector
 Used for the MC3M plug where microphone connects to amplifier chassis. Takes 13-16 in. hole and fit up to 3 sq. panels. Nickle finish and 3 contacts. Plug may be locked to socket. PC3F Chassis Con. -- 50c

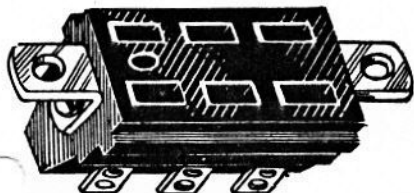

Heavy Duty Sockets

This socket for flush mounting in chassis or similar mounting. Has angles and of heavy bakelite with firm gripping nickle silver contacts. Available from 2 to 12 contacts.

- 2 contact --\$.85
- 4 contact -- 1.05
- 6 contact -- 1.25
- 8 contact--\$1.50
- 10 contact-- 1.70
- 12 contact-- 1.95

Microphone Cable

★ STANDS ★ and Accessories

De Luxe Floor Stand

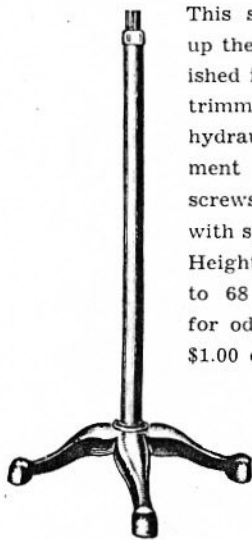

This stand is for fitting up the finest studio. Finished in black Japan with trimmings in chrome. Has hydraulic silent adjustment without thumb screws. Three leg base with spread of 15 1/2 inches. Height adjustable from 43 to 68 inches. Bushings for odd type microphones \$1.00 extra.

**Model 53-T
Stand
\$10.80**

Collapsible Floor Stand

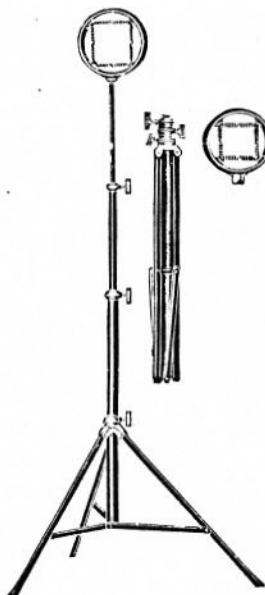

Used for remotes and completely folds up. Made of light durable metal and adjustable from 43 to 68 inches. Supplied less ring but may be had with ring for \$1.50 extra if desired. Bushings for odd type microphones \$1.00 extra.

**Collapsible
Floor Stand
\$15.00**

Banquet Stand



A well built stand adjustable up to 20 inches finished in black Japan with chrome trimmings. Heavy base assures freedom from toppling over. Supplied less ring. Bushings \$1.00 extra for odd microphones.

Banquet Stand \$7.50

Desk Stand



A fine heavy based stand for all types of microphones that will give a life time of wear. Supplied less ring. Bushings for odd type microphones \$1.00 extra. The desk stand should be of heavy design to prevent cord weight from pulling it off of the desk or table.

Desk Stand \$6.50

AMPERITE BOOM (Model FSB)

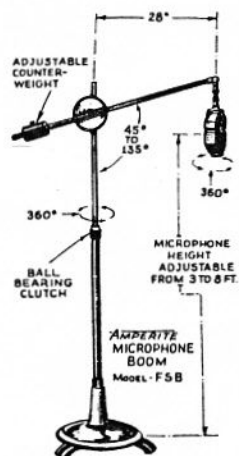

Adjustable in any direction.

Noiseless action permits noiseless adjustment while operating.

Adjustable counterweight and friction clutch provide smooth and easy operation: The Boom can be lowered or raised by mere pressure of the hand, without requiring any locking devices.

Microphone height can be varied from 36" to 96". Length of Boom arm, 28". (Other lengths obtained upon request at slight extra charge.)

**PRICE
30.00**

CRYSTAL MICROPHONE CABLE SHIELDED — RUBBER JACKETED



SINGLE CONDUCTOR

Code	Put-up	Approx. O.D.	Standard Package	Weight Ea. in lbs.	List Price Each
1252	100' spool	7/32"	3	3.0	\$ 7.30
1253	250' spool	7/32"	1	6.75	17.65
1253A	500' spool	7/32"	1	13.5	34.50



SHIELDED RUBBER JACKETED MICROPHONE CABLES

Conductors all color-coded. Braided with tinned copper shield. Heavy Jacket Tough Black Polished Rubber applied overall. Will withstand severe service. Adaptable to carbon, condenser, and moving coil microphones. **POSITIVELY WATERPROOF**—excellent for field microphones.

Code	Put-up	Approx. O.D.	Standard Package	Weight Ea. in lbs.	List Price Each	Code	Put-up	Approx. O.D.	Standard Package	Weight Ea. in lbs.	List Price Each
1185	100' spool, 2 conductor	11/32"	1	7.5	\$8.65	1181	250' spool, 4 conductor	3/8"	1	27.0	\$28.90
1186	250' spool, 2 conductor	11/32"	1	20.7	21.50	1181A	500' spool, 4 conductor	3/8"	1	52.0	56.95
1186A	500' spool, 2 conductor	11/32"	1	39.4	42.70	1182	100' spool, 5 conductor	3/8"	1	10.5	13.60
1187	100' spool, 3 conductor	11/32"	1	9.5	9.90	1183	250' spool, 5 conductor	3/8"	1	28.0	33.95
1188	250' spool, 3 conductor	11/32"	1	25.7	24.90	1183A	500' spool, 5 conductor	3/8"	1	54.0	67.15
1188A	500' spool, 3 conductor	11/32"	1	49.4	49.05	1189	100' spool, 6 conductor	7/16"	1	15.0	15.50
1180	100' spool, 4 conductor	3/8"	1	10.0	11.50	1190	250' spool, 6 conductor	7/16"	1	39.0	38.55
						1190A	500' spool, 6 conductor	7/16"	1	76.0	76.30

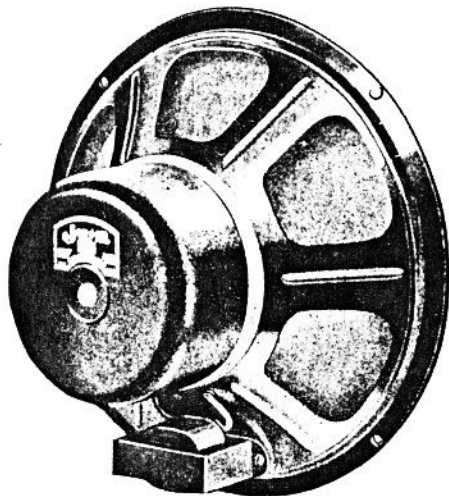

New Permanent Magnet Speakers Eliminate the Field Coil Used in Conventional Electro-Dynamic Designs . . . The Sensitivity and Efficiency of These New Speakers is Startling . . . Power Handling Capacity is High . . . and They Have Positive Protection Against Dust and Dirt . . . All Available With Adjustable, or fixed Impedance Transformers . . . or less Transformers.

PM (PERMANENT MAGNET) 10" - 12" SPEAKERS

Jensen Registered Trade Mark

With Adjustable Impedance Transformers

All "C" Model speakers have the same size magnet and the voice coils are 1-inch in diameter. Models PM10-C and PM12-C are fully equal to good 10 inch and 12 inch speakers energized with field coil.

Jensen PM speakers are logical and equally as satisfactory as field energized speakers for all radio broadcasting service. They offer high output efficiency, full 12" cone design if desired, wide response and completely do away with field supplies making installation simple.

The Model PM-8-C may be used in small rooms with excellent satisfaction and the same may be said for the PM-10-C. The PM-12-C is excellent for all radio monitoring service while the PM-12-B is a speaker having quality equal to only the better grade of field excited speakers and in the A12-PM speaker we have a unit that is the zenith in loud speaker design, surpassing most 12" speakers of the field excited type and will produce not only unusual fidelity of tone but large volume as well, making it well suited

for auditorium studios and large reception rooms. Most models listed on this page may be had in the Peri-Dynamic wall cabinets shown on the next page.

PRICES AND DESIGN DATA

PM-8-C Speakers (8 inch)

Model	Impedance	Price
ST-227	500	\$5.85
ST-230	6	5.10

PM-12-C Speakers (12 inch)

ST-247	500	\$9.30
ST-250	6	8.55

A12-PM Speakers (12 inch)

ST-255	500	\$21.90
ST-257	8	20.85

PM-10-C Speakers (10 inch)

Model	Impedance	Price
ST-243	500	\$7.50
ST-246	6	6.75

PM-12-B Speakers (12 inch)

ST-251	500	\$14.70
ST-254	8	13.80

Note--All of above speakers may be had with 4400 ohm transformers at no extra cost over 500 ohm models. Other impedances add \$1.00

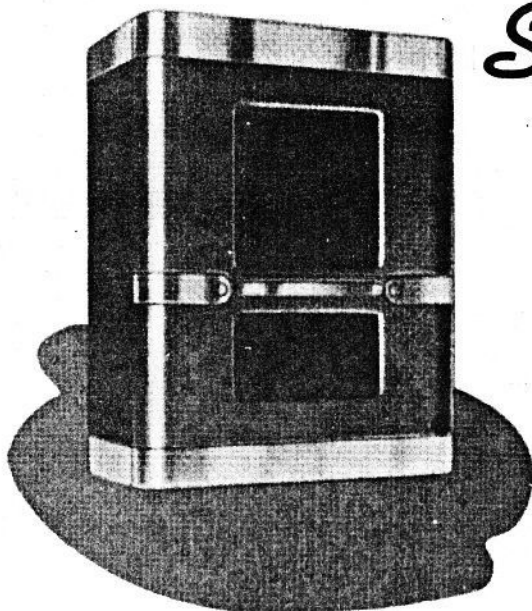

Special

HIGH FIDELITY MODEL MT-8

for

- *Monitoring*
- *Recording Studios*
- *Television*
- *All similar applications where audio-electric system is free from inherent or source distortion.*

For Average Use

WE have learned by long experience that it is good practice to compromise the performance ability of loud speakers to the anticipated operating requirements likely to be met when the speaker goes into operation. For example, in their most conventional application loud speakers are likely to have middle frequency response adjusted to deliver a maximum amount of apparent sensitivity. Relatively high power handling capacity is usually incorporated and response in the high frequency range is likely to be sharply attenuated to provide for the probability of high frequency distortion at the source or within the system. A loud speaker with design and performance influenced by such tenets is likely to be most acceptable for average use.

For Exacting Use

There are, however, many applications where operating conditions and performance requirements call for a loud speaker with altogether different design and performance ability. In this loud speaker compromise is in the direction of uniform acoustic output throughout the audio spectrum. The object is to provide a device which will recreate the original sound just as accurately as possible. Such a loud speaker is highly qualified for use where there is little or no extraneous energy or distortion in the input and amplifier system and where the intent is to utilize all of the audio spectrum essential to the most accurate reproduction of sound. In the past a device capable of such performance ability

has required two or more loud speakers operating as a system. Such systems are, of course, relatively expensive and often their increased power handling capacity and other advantages are not essential to the proposed application. Jensen Model MT-8 Reproducer has been developed to serve in the capacity of such a high quality device at a cost which is only a fraction of these multiple speaker systems. As such, this new Reproducer represents an outstanding achievement.

Model MT-8

We know of no Reproducer having all the advantages of this new Jensen product; only a few approach it in ability and then only at several times the cost of Model MT-8. A single loud speaker is employed, working in conjunction with the well known *Peri-dynamic* and *Bass Reflex* principles. This latter principle is responsible for the exceptionally good low frequency response of the Reproducer and no other single speaker device approaches this product in that regard, so far as we know. No complex diaphragms or voice coils are used and no metallic material is used in the construction of the diaphragm. The polar characteristic of the reproducer is remarkably good and the power handling capacity is adequate for recommended applications. The reproducer performs best from a substantially straight line audio electric amplifier output, therefore no special amplifiers or equalizers are required. And, finally, all of this is accomplished at a very low cost; a cost which will allow the use of this Reproducer in the thousands of locations heretofore denied the use of a reproducer of this character because of cost alone.

CABINET SIZE 24" BY 17½" BY 11½". POWER HANDLING CAPACITY 6 WATTS. SUPPLIED AS PRICED BELOW WITH YOUR CHOICE OF 500, 1000 OR 1500 OHM TRANSFORMER. MODEL ST559 IS PERMANENT MAGNET TYPE AND ST561 HAS 2500 OHM FIELD. PRICE EITHER MODEL WITH TRANSFORMER \$21.00

LINEAR STANDARD AUDIO TRANSFORMERS

OVERALL DIMENSIONS

	Mtg. Dim.		
LS-1	1 15/16	x 2 7/16	
LS-2	2 11/16	x 3 11/16	
LS-3	4 3/16	x 5 1/32	
LS-4	5 3/4	x 5 3/4	
LS-5	7 1/4	x 7 1/4	
L	W	H	
2 9/16	3 3/16	3 11/16	
3 1/2	4 3/8	4 5/8	
5	5 3/4	5 3/16	
6 7/16	6 7/16	5 3/8	
8	8	6 1/2	

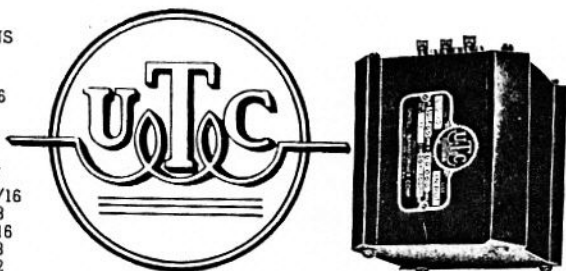

UNITED TRANSFORMER CORPORATION TRANSFORMERS ARE CARRIED IN STOCK FOR THE CONVENIENCE OF BROADCAST CUSTOMERS THAT BUILD EQUIPMENT OR NEED REPAIRS. THIS MIDWEST LOCATION OF A COMPLETE STOCK OF QUALITY TRANSFORMERS USED IN BROADCASTING STATIONS BRINGS THEM DAYS CLOSER TO YOU AT REGULAR WHOLESALE PRICES. ORDER BY NUMBER. SPECIAL TYPES GLADLY QUOTED.

MODEL LS10---50, 125, 200, 250, 333, 500 OHMS 60,000 OHMS SEC.	PRICE \$9.00
MODEL LS10X---SAME AS LS10 ONLY DUAL SHIELD	PRICE \$12.00
MODEL LS18---SAME AS LS10 ONLY FOR HIGH LEVEL PRIMARY	PRICE \$13.20
MODEL LS30---LINE TO LINE 50,200,250,333,500 OHMS PRI. AND SEC.	PRICE \$9.00
MODEL LS30X---SAME AS LS30 ONLY DUAL SHIELDING	PRICE \$12.00
MODEL LS30---15,000 OHM PRIMARY TO 50, 125, 200, 250, 333, 500 OHMS. FOR 6J7 TRIODE, 6C5, 6C6 TRIODE ETC.	PRICE \$9.00
MODEL LS30X---SAME AS LS30 ONLY DUAL SHIELDING	PRICE \$12.00
MODEL LS39---HIGH IMPEDANCE TRIODE SUCH AS 6F5, CRYSTAL PICK UP, ETC. 100,000 OHM PRI. TO 50, 125, 200, 250, 333 AND 500 OHMS. NO CURRENT IN PRIMARY	PRICE \$9.00
MODEL LS39X---SAME AS LS39 ONLY DUAL SHIELDING	PRICE \$12.00
MODEL LS150---BRIDGING TRANSFORMER 4000 OHMS PRI. TO 50, 125, 200, 250, 333 AND 500 OHMS SECONDARY	PRICE \$9.00
MODEL LS151---SAME AS LS150 ONLY PRIMARY 16,000 OHMS	PRICE \$9.00
MODEL LS21---SINGLE PLATE 8000 TO 15,000 OHM PRI. TO 135,000 OHM SINGLE OR P.P. SEC. TURN RATIO 1.5-1	PRICE \$7.80
MODEL LS22---SAME AS LS21 ONLY P.P. PRI. TURN RATIO 1.6-1	PRICE \$13.20
MODEL LS5---50, 125, 200, 250, 333, 500 OHMS PRI. TO CLASS B 838s, 805s, 203-A ETC	PRICE \$18.00
MODEL LS47X---P.P. 2A3, 6A5G OR 300-As TO CLASS B 838s, 805s, 203-As AND SIMILAR	PRICE \$13.20
MODEL LS48---P.P. 845s TO CLASS B 849, 250TH OR SIMILAR	PRICE \$21.00

OUTPUT TRANSFORMERS

MODEL LS66---CLASS B 838, 805s, 203-As AND SIMILAR TO 5000, 3500, 2500, 2100, 1250, 600 OHMS. NO SEC. CURRENT	PRICE \$42.00
MODEL LS67---SAME AS LS66 ONLY SEC. 10,000 AND 2500 OHMS	PRICE \$42.00
FOLLOWING MODELS ALL HAVE SECONDARIES OF 50, 125, 200, 250, 333 AND 500 OHMS	
MODEL LS52---PRI. 8000 OHMS FOR 45s, 250s, 6F6s TRIODES IN P.P.	PRICE \$12.00
MODEL LS55---PRI. 5000 OR 3000 PLATE TO PLATE FOR P.P. 2A3s, 6A5Gs 300As, 275As, 6A3s AND SIMILAR	PRICE \$12.00
MODEL LS58---SAME AS LS55 ONLY FOR P.P. PARALLEL TUBES	PRICE \$18.00
MODEL LS61---10,000 OHMS AND 6000 OHMS PLATE TO PLATE FOR 6B5s, 6A6, 53, 6F6, 7LA, 59, 79 AND 89 AND SIMILAR	PRICE \$8.40
MODEL LS64---FOR P.P. 845 TUBES CLASS A	PRICE \$21.00
MODEL LS6L1---P.P. 6L6s SELF BIAS WITH TERTIARY WINDING FOR FEED BK.	PRICE \$18.00
MODEL LS6L4---P.P. 6L6s FIXED BIAS OR P.P. PAR. 6L6s SELF BIAS WITH TERTIARY WINDING FOR FEED BACK.	PRICE \$21.00

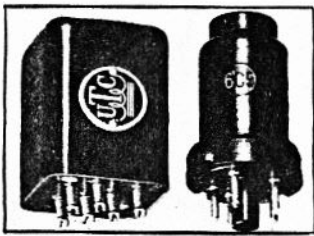

ULTRA COMPACT HIGH FIDELITY AUDIO UNITS

MODEL A-10---	50 TO 500 OHMS PRI. 50,000 OHM SEC.	PRICE \$6.00
MODEL A-12---	50 TO 500 OHMS PRI. P.P. SEC. 80,000 OHMS IN 2 SECTIONS	PRICE \$6.00
MODEL A-14---	30 OHMS PRI. 50,000 OHM SEC. 2 SECT.	PRICE \$5.40
MODEL A-20---	50 TO 500 OHMS BOTH PRIMARY AND SEC.	PRICE \$6.00
MODEL A-24---	8000 TO 15,000 OHM PLATE TO 50 TO 500 OHM SECONDARY	PRICE \$6.00
MODEL A-26---	P.P. LOW LEVEL PLATES 8000 TO 15,000 OHMS TO 50 TO 500 OHM SECONDARY	PRICE \$6.00

ALL ABOVE UNITS HUM BUCKING DESIGN PLUS OR MINUS
2 DB. FROM 30 TO 20,000 CYCLES.



SPECIAL REMOTE OUTPUT TRANSFORMER---USED IN ALL GATES REMOTE AMPLIFIERS TO OBTAIN HIGHER OUTPUT LEVEL WITHOUT DISTORTION THAN POSSIBLE FROM MOST STANDARD TYPES. BUILT FOR A 6F6 AS A TRIODE TO 50, 200 OR 500 OHMS. OPEN MOUNT FULLY IMPREGNATED WITH LUG TERMINALS. PRICE \$5.26

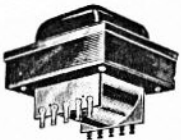

REMOTE POWER TRANSFORMER---THIS DESIGN USED IN ALL GATES A.C. OPERATED REMOTE EQUIPMENT. HAS 6.3 VOLTS C.T. AT 2 AMPS. 5 VOLTS AT 2 AMPS. AND DELIVERS 300 VOLTS FILTERED AT 50 MA. FULLY CASED WITH LUG TERMINALS. PRICE \$2.00



AMPLIFIER POWER TRANSFORMER---THIS DELUXE UNIT MADE ESPECIALLY FOR GATES AT GATES ENGINEERING SPECIFICATIONS. FULLY CASED AND WAX IMPREGNATED WITH LUG TERMINALS OUT OF BOTTOM. STREAM LINED CASE IN BLACK RIPPLE ENAMEL. DELIVERS 6.3 VOLTS AT 6 AMPS., 2.5 VOLTS AT 6 AMPS., 2.5 VOLTS AT 3 AMPS., 5 VOLTS AT 3 AMPS., AND 310 VOLTS AT LARGE SECONDARY CURRENT OF 175 MA. ALL WINDINGS CENTER TAPPED. A DELUXE TRANSFORMER IN EVERY RESPECT. PRICE \$12.00

REMOTE CHOKE COIL---USED IN ALL GATES REMOTE AMPLIFIERS THAT ARE A.C. OPERATED. OPEN MOUNT. INDUCTANCE 20 HENRIES AT 40 MA. WIRE LEADS. PRICE 90¢

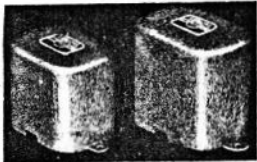

AMPLIFIER CHOKE COIL---ILLUSTRATED TO LEFT. AVAILABLE IN TWO TYPES. TYPE A40 HAS INDUCTANCE OF 15 HENRIES AT 85 MA. TYPE A44 HAS INDUCTANCE OF 10 HENRIES AT 150 MA. FULLY CASED WITH LUG TERMINALS AND WAX IMPREGNATED. A DELUXE CHOKE THAT WILL NOT HEAT. PRICE A40 \$1.70 PRICE A44 \$2.10



OIL FILLED AMPLIFIER CONDENSER---USED BY GATES IN ALL SPEECH UNITS. A DELUXE OIL FILLED 600 VOLT 4 MFD. CONDENSER THAT WILL NOT WEAR OUT. BOTTOM MOUNT LUG CONNECTION. PRICE \$1.95

REMOTE FILTER CONDENSER---A UNIQUE CONDENSER SIMILAR TO APPEARANCE OF OIL FILLED UNIT ILLUSTRATED ONLY HAS PLUG IN BASE AND 3 SECTIONS OF 8 MFD. 450 VOLT ELECTROLYTIC CONDENSERS. PLUGS INTO STANDARD 4 PRONG TUBE SOCKET AND NO LARGER IN DIAMETER. PRICE \$1.95

CATHODE BY PASS CONDENSER---A SINGLE SECTION 25 VOLT 20 MFD. CONDENSER IN SQUARE PAPER CASE WITH LUG TERMINALS AND MOUNTING FEET. PRICE 45¢

3 SECTION CATHODE BY PASS CONDENSER---HAS 3 SECTIONS OF 20 MFD. 25 VOLT CONDENSERS. WIRE LEADS IN SQUARE PAPER CASE AND MOUNTING FEET. PRICE \$1.20

WE CARRY A COMPLETE STOCK OF ALL INCIDENTAL PARTS SUCH AS TUBE SOCKETS, PILOT LIGHT BRACKETS, TOGGLE SWITCHES, RESISTORS, CONDENSERS, ETC.